



100% American Made Cabinets

Timberline

U.S. Made-To-Order Collection





Why Choose Timberline



100% MADE IN USA CABINETS

Every single cabinet in this brochure is 100% made in the USA with sustainably sourced, engineered wood. That means you know you are getting a reliable product from a reliable source.



CUSTOM MADE DESIGNS

We know you want something a little unique just for you. We can adapt most of our cabinets to suit exactly what you need to bring some magic to your new bathroom.



MIX AND MATCH

You can mix and match your selections from our huge range of cabinet colors and handles. Personalize your vanity to create just the look you are after!

Add Value



We're locally grown, family owned and dedicated to putting quality first.

TIMBERLINE – A BATH FURNITURE MANUFACTURER

Since 2007, Timberline has designed and crafted made-to-order vanities to bring modern bathrooms to life. A bathroom is a sanctuary – a place for you to unwind, wash off the day and relax. So, it needs to be a space that is personal and special.

Originally based in regional New South Wales, Australia, the firm's expanding Armidale factory is home to state-of-the-art technology and highly skilled craftsmen – a jewel in the local business community.

Timberline has expanded into the American market by opening a manufacturing facility in Redwood Falls, a small town in southern Minnesota. We are a family-owned and family-run business that is passionate about hand crafting American-made bathroom vanities, mirrored cabinets and linen closets in a fast, easy-to-deal-with manner.

Talk to our sales team today to discover how the Timberline difference will help you come home to a space that feels truly personal.



Cullen Vanity 48" CUL-V-48-C-QUU-L-SB-BP10G-WL-1-AGG | \$6,139. Juniper Mirrored Cabinet JUN-MC-48-W-SB | \$2,252

Add Value



Cullen Vanity 60" CUL-V-60-D-SSU-F-LG-CRB-AW-0 | \$7,174. Ridge Mirrored Cabinet RID-MC-16-W-GB | \$1,732.

Contents

6	Vanities	■
26	Mirrored Cabinets & Shelves	■
40	Linen Closets	■
48	Pricelist	■
78	Customizing Upgrades	■
82	Cabinet Options	■
101	Order Form/Checklist	
102	Installation & Warranty	





Vera Vanity 32" VER-V-32-C-QUU-F-CL-BP10B-TQ-1 | \$4,822. Willow Mirrored Cabinet WIL-MC-32-W-CL | \$1,936.

Vanities

- 8 Cullen
- 10 Finn
- 12 Kodiak
- 14 Linden
- 16 Maren
- 18 Tuscany
- 20 Vera
- 22 Wells
- 24 Wall-to-Wall



Cullen



01.

The Cullen is a classic all-rounder, providing the practicality of door and drawer storage whilst leaving you many options for cabinet finishes, handles and tops. If you want a simple yet stylish design, the Cullen is a fail-proof option for your bathroom.



[01.] Cullen Vanity 1500mm / 60" | CUL-V-60-D-SSU-F-LG-CRB-AW-1 | \$7,174
CABINET: Light Grey Satin (Tier 2) | **HANDLES:** Black Crescent Pull | **TOP:** SilkSurface Arctic White | **SINKS:** Undermount | **FAUCET HOLE:** 1

[02.] Cullen Vanity 1200mm / 48" | CUL-V-48-C-QUU-L-SB-BP10G-WL-1-AGG | \$6,139
CABINET: Sheer Beauty (Tier 1) | **HANDLES:** Gold Bar Handle 10" | **TOP:** Quartz Whitehall | **SINK:** Undermount | **FAUCET HOLE:** 1 | **LEGS:** Gold Angle Legs

[03.] Cullen Vanity 600mm / 24" | CUL-V-24-C-CRE-W-RH-BP3B-1 | \$2,067
CABINET: Rhapsody (Tier 1) | **HANDLES:** Black Bar Pull 3" | **TOP:** Crest | **FAUCET HOLE:** 1

AVAILABLE COLOR RANGES



ANY TIER 1
WOODGRAIN LAMINATE



ANY TIER 2
WOOD VENEER



ANY TIER 2
PAINTED COLOR

AVAILABLE MOUNTING



WALL HUNG



FLOORSTANDING



LEGS/FREESTANDING

AVAILABLE SIZES

500MM /
19 11/16"

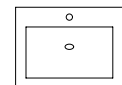

600mm / 24"

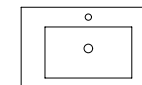

800mm / 32"

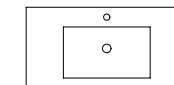

900mm / 36"

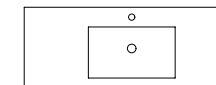

1200mm / 48"

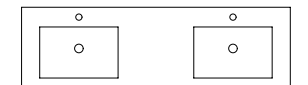

1500mm / 60"

AVAILABLE TOP OPTIONS



**CREST
MINERAL COMPOSITE**
White Gloss only. 1 or 3 Faucet holes



**PEAK
MINERAL COMPOSITE**
White Gloss only. 1 or 3 Faucet holes



**SILKSURFACE WITH
UNDERMOUNT**
Any Color. 0, 1, or 3, Faucet holes



**SILKSURFACE WITH
VESSEL SINK**
Any Color. 0, 1, or 3, Faucet holes



**QUARTZ WITH
UNDERMOUNT**
Any Color. 0, 1, or 3, Faucet holes



**QUARTZ WITH
VESSEL SINK**
Any Color. 0, 1, or 3, Faucet holes

Finn



01.

The Finn vanity is the perfect addition to your bathroom if you're looking to add a touch of warmth and style. The woodgrain finish and surround gives it a contemporary vibe, while the all-drawer design provides ample storage for all of your bathroom essentials.



02.



03.

[01.] Finn Vanity 900mm / 36" | FIN-V-36-C-LMA-W-SB-PTO-SB-0-ROU | \$2,473
CABINET: Sheer Beauty (Tier 1) | **HANDLE:** Push-to-Open | **TOP:** Laminate Sheer Beauty | **SINK:** Round | **FAUCET HOLE:** 0

[02.] Finn Vanity 1200mm / 48" | FIN-V-48-C-LMA-W-RH-PTO-RH-0-SQU | \$3,036
CABINET: Rhapsody (Tier 1) | **HANDLE:** Push-to-Open | **TOP:** Laminate Rhapsody | **SINK:** Square | **FAUCET HOLE:** 0

[03.] Finn Vanity 1500mm / 60" | FIN-V-60-D-LMA-F-KC-SQ7G-KC-0-ROU | \$4,863
CABINET: Kiss Curl (Tier 1) | **HANDLES:** Gold Square Pulls 7 1/2" | **TOP:** Laminate Kiss Curl | **SINKS:** Round | **FAUCET HOLE:** 0

AVAILABLE COLOR RANGES



ANY TIER 1
WOODGRAIN LAMINATE

AVAILABLE MOUNTING

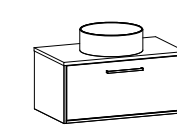

WALL HUNG



FLOORSTANDING

AVAILABLE SIZES

500MM /
19 11/16"

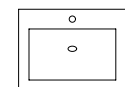

600mm / 24"

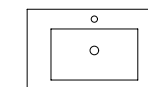

800mm / 32"

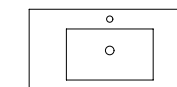

900mm / 36"

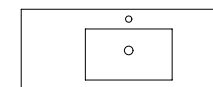

1200mm / 48"

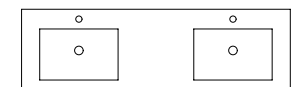

1500mm / 60"

AVAILABLE TOP OPTIONS



Any Woodgrain Laminate Color.
0, 1, or 3, Faucet holes

AVAILABLE VESSEL SINKS



Round



Square



Rectangle (faucet landing is on the sink)

Kodiak



The Kodiak has 5-piece style doors and drawers, adding a traditional touch to your bathroom with a sophisticated shaker door style. Choose from our wood veneer or painted color options and finish it off with your choice of handles.



[01.] Kodiak Vanity 1200mm / 48" | KOD-V-48-C-SSU-L-OS-CRN-CA-1-ARN | \$5,192
CABINET: Olive Satin (Tier 2) | **HANDLES:** Nickel Crescent Pull | **TOP:** SilkSurface Carrara | **SINK:** Undermount | **FAUCET HOLE:** 1 | **LEGS:** Nickel Arrow

[02.] Kodiak Vanity 800mm / 32" | KOD-V-32-C-QUA-W-AG-BP3N-CK-0-ROU | \$4,425
CABINET: Ash Grey (Tier 2) | **HANDLES:** Nickel Bar Pull 3" | **TOP:** Quartz Carrick | **SINK:** Round | **FAUCET HOLE:** 0

[03.] Kodiak Vanity 900mm / 36" | KOD-V-36-C-PEA-F-LG-KNB-1 | \$3,161
CABINET: Light Grey Satin (Tier 2) | **HANDLES:** Black Round Knob | **TOP:** Peak | **FAUCET HOLE:** 1

AVAILABLE COLOR RANGES



AVAILABLE MOUNTING



AVAILABLE SIZES

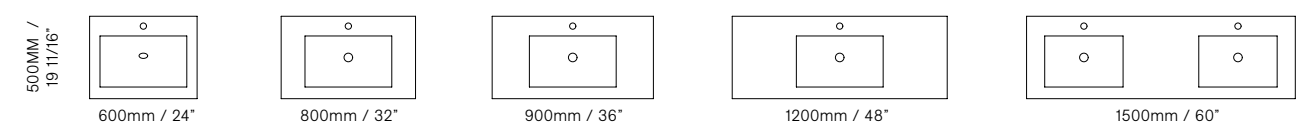

AVAILABLE TOP OPTIONS



Linden



One of our top sellers, the Linden brings you Timberline class at an affordable price! With the luxury of all-drawers, this vanity will elevate your bathroom and give you plenty of easy access to your storage space.



[01.] Linden Vanity 900mm / 36" | LIN-V-36-C-SSU-L-KC-CRG-AW-3-AGG | \$4,176
CABINET: Kiss Curl (Tier 1) | **HANDLES:** Gold Crescent Pull | **TOP:** SilkSurface Arctic White | **SINK:** Undermount | **FAUCET HOLES:** 3 | **LEGS:** Gold Angle

[02.] Linden Vanity 1200mm / 48" | LIN-V-48-C-QUU-W-EG-OV13G-CT-0 | \$5,654
CABINET: Emerald Green Satin (Tier 2) | **HANDLES:** Gold Ova Top Pull 13 3/4" | **TOP:** Quartz Colton | **SINK:** Undermount | **FAUCET HOLE:** 0

[03.] Linden Vanity 600mm / 24" | LIN-V-24-C-QUA-F-GB-BP6B-TQ-0-SQU | \$4,316
CABINET: Grey Beige Satin (Tier 2) | **HANDLES:** Black Bar Pull 6" | **TOP:** Quartz Torquay | **SINK:** Square | **FAUCET HOLE:** 0

AVAILABLE COLOR RANGES



ANY TIER 1
WOODGRAIN LAMINATE



ANY TIER 2
WOOD VENEER



ANY TIER 2
PAINTED COLOR

AVAILABLE MOUNTING



WALL HUNG



FLOORSTANDING



LEGS/FREESTANDING

AVAILABLE SIZES

500MM /
19 11/16"

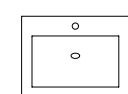

600mm / 24"

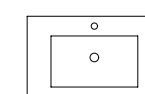

800mm / 32"

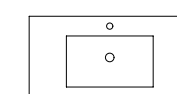

900mm / 36"

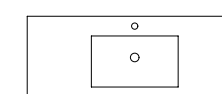

1200mm / 48"

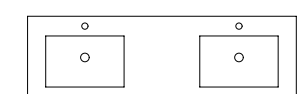

1500mm / 60"

AVAILABLE TOP OPTIONS



CREST
MINERAL COMPOSITE
White Gloss only. 1 or 3 Faucet holes



PEAK
MINERAL COMPOSITE
White Gloss only. 1 or 3 Faucet holes



SILKSURFACE WITH
UNDERMOUNT
Any Color. 0, 1, or 3, Faucet holes



SILKSURFACE WITH
VESSEL SINK
Any Color. 0, 1, or 3, Faucet holes



QUARTZ WITH
UNDERMOUNT
Any Color. 0, 1, or 3, Faucet holes



QUARTZ WITH
VESSEL SINK
Any Color. 0, 1, or 3, Faucet holes

Maren



01.

This vanity marries classic design with an elegant modern look. But it's not just a pretty face - the Maren also offers practicality, thanks to its doors and drawers that provide ample storage options.



[01.] Maren Vanity 1500mm / 60" | MAR-V-60-D-PEA-W-SR-OV7G-1 | \$4,258
CABINET: Sugar Rush (Tier 1) | **HANDLES:** Gold Ova Top Pull 7 3/4" | **TOP:** Peak | **FAUCET HOLE:** 1

[02.] Maren Vanity 900mm / 36" | MAR-V-36-C-QUA-W-OS-KNG-TQ-0-SQU | \$4,609
CABINET: Olive Satin (Tier 2) | **HANDLES:** Gold Round Knob | **TOP:** Quartz Torquay | **SINK:** Rectangle | **FAUCET HOLE:** 0

[03.] Maren Vanity 1500mm / 60" | MAR-V-60-D-SSU-F-NO-IN6B-MS-0 | \$6,863
CABINET: Night Owl (Tier 1) | **HANDLES:** Black Industrial Pull 6" | **TOP:** SilkSurface Moonstone | **SINKS:** Undermount | **FAUCET HOLE:** 0

AVAILABLE COLOR RANGES



ANY TIER 1
WOODGRAIN LAMINATE



ANY TIER 2
WOOD VENEER



ANY TIER 2
PAINTED COLOR

AVAILABLE MOUNTING



WALL HUNG



FLOORSTANDING

AVAILABLE SIZES

500MM /
19 11/16"

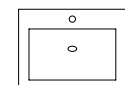

600mm / 24"

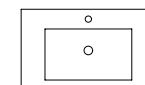

800mm / 32"

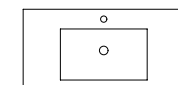

900mm / 36"

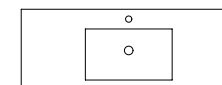

1200mm / 48"

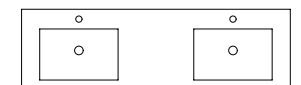

1500mm / 60"

AVAILABLE TOP OPTIONS



**CREST
MINERAL COMPOSITE**
White Gloss only. 1 or 3 Faucet holes



**PEAK
MINERAL COMPOSITE**
White Gloss only. 1 or 3 Faucet holes



**SILKSURFACE WITH
UNDERMOUNT**
Any Color. 0, 1, or 3, Faucet holes



**SILKSURFACE WITH
VESSEL SINK**
Any Color. 0, 1, or 3, Faucet holes



**QUARTZ WITH
UNDERMOUNT**
Any Color. 0, 1, or 3, Faucet holes



**QUARTZ WITH
VESSEL SINK**
Any Color. 0, 1, or 3, Faucet holes

Tuscany



Looking for something a little more architectural? Inspired by Italian design trends, the Tuscany combines a sleek, floating vanity top supported by engineered steel brackets with a separate storage cabinet.



NOTE: Drawer front on storage cabinet available in matching laminate as top and sides, or in any other finish as a two tone option. Drawers are Push-to-Open as standard. Handles available.

[01.] Tuscany Vanity 1200mm / 48" | TUS-V-48-C-LBA-W-KC-PTO-KC-0-SQU | \$5,932
CABINET: Kiss Curl (Tier 1) | **HANDLE:** Push-to-Open | **TOP:** Laminate Kiss Curl | **FAUCET HOLE:** 0 | **SINK:** Square

[02.] Tuscany Vanity 900mm / 36" | TUS-V-36-C-QBA-W-RH-PTO-CN-0-ROU | \$6,110
CABINET: Rhapsody/White Satin (Tier 2*) | **HANDLE:** Push-to-Open | **TOP:** Quartz Colton | **FAUCET HOLE:** 0 | **SINK:** Round | ***NOTE:** Two-Tone drawer front in White Satin

[03.] Tuscany Vanity 1200mm / 48" | TUS-V-48-L-QBA-W-TT-PTO-CK-0-ROU | \$6,863
CABINET: Tete a Tete (Tier 1) | **HANDLE:** Push-to-Open | **TOP:** Quartz Carrick | **FAUCET HOLE:** 0 | **SINK:** Round

AVAILABLE COLOR RANGES



ANY TIER 1
WOODGRAIN LAMINATE

AVAILABLE MOUNTING

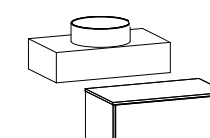

WALL HUNG

AVAILABLE SIZES



AVAILABLE TOP OPTIONS

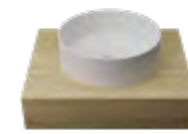

LAMINATE BOX WITH VESSEL SINK
Any Color. 0, 1, or 3, Faucet holes



QUARTZ BOX WITH VESSEL SINK
Any Color. 0, 1, or 3, Faucet holes

AVAILABLE VESSEL SINKS



Round



Square



Rectangle (faucet landing is on the sink)

Vera



01.

The Vera vanity maximizes your storage options with its door and open shelf combination design. Its an easy way to show off your favorite towels, without sacrificing any valuable drawer space.



02.



03.

[01.] Vera Vanity 1500mm / 60" | VER-V-60-D-PEA-W-EG-PTO-1 | \$4,051
CABINET: Emerald Green Satin (Tier 2) | **HANDLES:** Push-to-Open | **TOP:** Peak | **FAUCET HOLE:** 1

[02.] Vera Vanity 800mm / 32" | VER-V-32-C-QUU-F-CL-BP10B-TQ-1 | \$4,822
CABINET: Chocolate (Tier 2) | **HANDLES:** Black Bar Pull 10" | **TOP:** Quartz Torquay | **SINK:** Undermount | **FAUCET HOLE:** 1

[03.] Vera Vanity 1200mm / 48" | VER-V-48-C-QUA-W-BL-OV13G-CN-0-SQU | \$5,806
CABINET: Black Satin (Tier 2) | **HANDLES:** Nickel Ova Top Pull 13 3/4" | **TOP:** Quartz in Colton | **FAUCET HOLE:** 1 | **SINK:** Square

AVAILABLE COLOR RANGES



ANY TIER 1
WOODGRAIN LAMINATE



ANY TIER 2
WOOD VENEER



ANY TIER 2
PAINTED COLOR

AVAILABLE MOUNTING



WALL HUNG



FLOORSTANDING

AVAILABLE SIZES

500MM /
19 11/16"

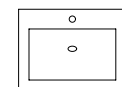

600mm / 24"

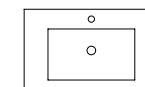

800mm / 32"

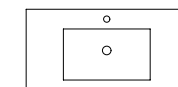

900mm / 36"

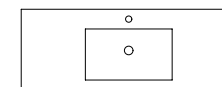

1200mm / 48"

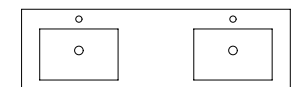

1500mm / 60"

AVAILABLE TOP OPTIONS



**CREST
MINERAL COMPOSITE**
White Gloss only. 1 or 3 Faucet holes



**PEAK
MINERAL COMPOSITE**
White Gloss only. 1 or 3 Faucet holes



**SILKSURFACE WITH
UNDERMOUNT**
Any Color. 0, 1, or 3, Faucet holes



**SILKSURFACE WITH
VESSEL SINK**
Any Color. 0, 1, or 3, Faucet holes



**QUARTZ WITH
UNDERMOUNT**
Any Color. 0, 1, or 3, Faucet holes



**QUARTZ WITH
VESSEL SINK**
Any Color. 0, 1, or 3, Faucet holes

Wells



01.

The Wells vanity is minimalist styling at its best. It's sleek single level of drawers gives your bathroom a sophisticated and uncluttered look.



02.



03.

[01.] Wells Vanity 900mm / 36" | WEL-V-36-C-SSU-W-WH-CRG-CB-1 | \$3,817
CABINET: White Satin (Tier 2) | **HANDLE:** Gold Crescent Pull | **TOP:** SilkSurface Cobblonite | **SINK:** Undermount | **FAUCET HOLE:** 1

[02.] Wells Vanity 600mm / 24" | WEL-V-24-C-QUU-W-SS-IN10N-CN-0 | \$3,640
CABINET: Sunday Stroll (Tier 1) | **HANDLE:** Nickel Industrial Pull 10" | **TOP:** Quartz Colton | **SINK:** Undermount | **FAUCET HOLE:** 0

[03.] Wells Vanity 1200mm / 48" | WEL-V-48-C-SSA-W-DG-BP7G-MS-0-SQU | \$4,543
CABINET: Dark Grey Satin (Tier 2) | **HANDLES:** Gold Bar Pull 7" | **TOP:** Quartz Carrick | **FAUCET HOLE:** 0 | **SINK:** Square

AVAILABLE COLOR RANGES



ANY TIER 1
WOODGRAIN LAMINATE



ANY TIER 2
WOOD VENEER



ANY TIER 2
PAINTED COLOR

AVAILABLE MOUNTING

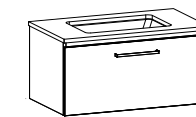

WALL HUNG

AVAILABLE SIZES

500MM /
19 11/16"

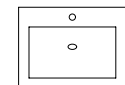

600mm / 24"

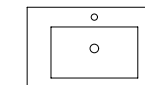

800mm / 32"

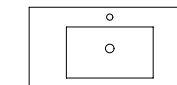

900mm / 36"

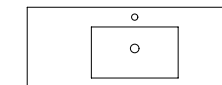

1200mm / 48"

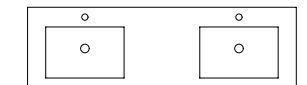

1500mm / 60"

AVAILABLE TOP OPTIONS



**CREST
MINERAL COMPOSITE**
White Gloss only. 1 or 3 Faucet holes



**PEAK
MINERAL COMPOSITE**
White Gloss only. 1 or 3 Faucet holes



**SILKSURFACE WITH
UNDERMOUNT**
Any Color. 0, 1, or 3, Faucet holes



**SILKSURFACE WITH
VESSEL SINK**
Any Color. 0, 1, or 3, Faucet holes



**QUARTZ WITH
UNDERMOUNT**
Any Color. 0, 1, or 3, Faucet holes



**QUARTZ WITH
VESSEL SINK**
Any Color. 0, 1, or 3, Faucet holes

Wall-to-Wall



[01.] Wall-to-Wall Vanity 37" - 48" | WTW-V-48-C-QUA-W-RH-BP3B-CN-0-ROU | \$5,349
CABINET: Rhapsody (Tier 1) | **HANDLES:** Black Bar Pull 3" | **TOP:** Quartz Colton | **SINK:** Round | **FAUCET HOLE:** 0 | **UPGRADES:** Cabinet Lighting Upgrade (SKU: LIGHTKIT) \$344 | Backsplash Upgrade (SKU: SPLASH-QU) \$483

[02.] Wall-to-Wall Vanity 24" - 32" | WTW-V-32-C-SSA-W-WH-IN6B-AW-0-SQU | \$3,568
CABINET: White Satin (Tier 2) | **HANDLES:** Black Industrial Handle 6" | **TOP:** Quartz Whitehall | **SINK:** Rectangle | **FAUCET HOLE:** 0

AVAILABLE COLOR RANGES



ANY TIER 1
WOODGRAIN LAMINATE



ANY TIER 2
WOOD VENEER



ANY TIER 2
PAINTED COLOR

AVAILABLE MOUNTING



WALL HUNG



FLOORSTANDING

AVAILABLE SIZES

500MM /
19 11/16"

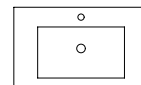

24" - 32"

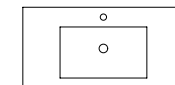

33" - 36"

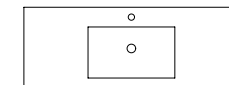

37" - 48"

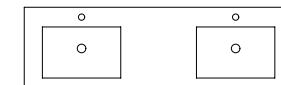

49" - 60"

AVAILABLE TOP OPTIONS



SILKSURFACE WITH
UNDERMOUNT
Any Color, 0, 1, or 3, Faucet holes



SILKSURFACE WITH
VESSEL SINK
Any Color, 0, 1, or 3, Faucet holes



QUARTZ WITH
UNDERMOUNT
Any Color, 0, 1, or 3, Faucet holes



QUARTZ WITH
VESSEL SINK
Any Color, 0, 1, or 3, Faucet holes



Juniper Mirrored Cabinet JUN-MC-36-W-RH | \$1,774 .

Mirrored Cabinets & Shelves

- 28 Isla
- 30 Juniper
- 32 Ridge
- 34 Sage
- 36 Willow
- 38 Floating Shelves



Isla Mirrored Cabinet



01.

The Isla mirrored cabinet combines good looks and practical storage. The unique corner shelves offer endless decor opportunities. Add under cabinet lighting for additional ambiance (additional charges apply).



02.

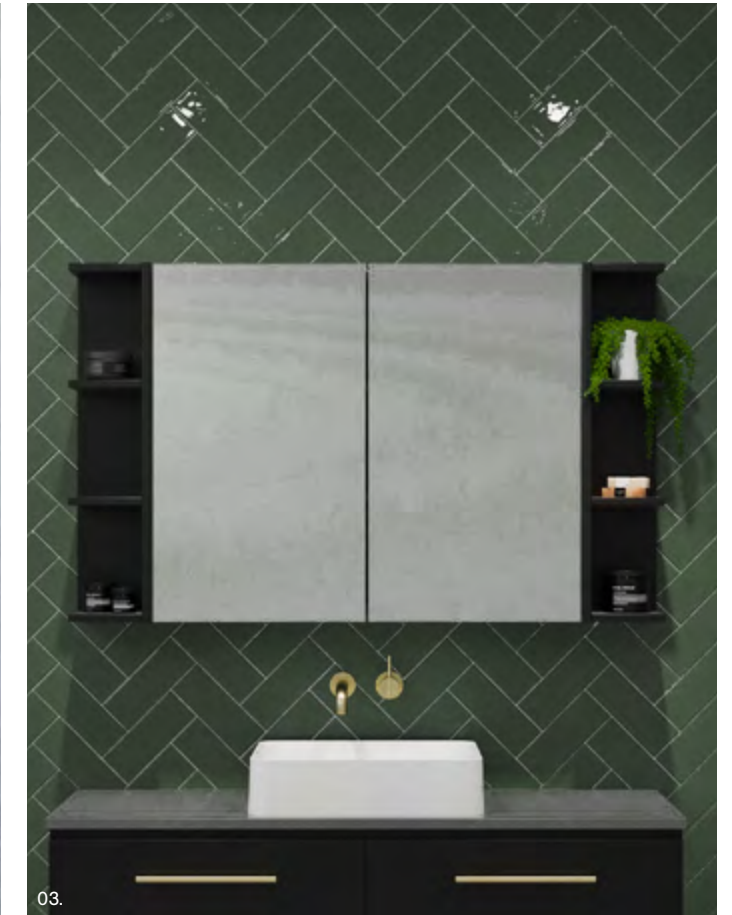

03.

[01.] Isla Mirrored Cabinet 1500mm / 60" | ISL-MC-60-W-EG | \$2,759 | Emerald Green Satin Cabinet (Tier 2)

[02.] Isla Mirrored Cabinet 900mm / 36" | ISL-MC-36-W-CL | \$2,029 | Chocolate Cabinet (Tier 2)

[03.] Isla Mirrored Cabinet 1200mm / 48" | ISL-MC-48-W-DG | \$2,490 | Dark Grey Satin Cabinet (Tier 2)

AVAILABLE COLOR RANGES



ANY TIER 1
WOODGRAIN LAMINATE



ANY TIER 2
WOOD VENEER



ANY TIER 2
PAINTED COLOR

AVAILABLE SIZES

760mm / 30"

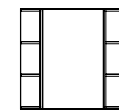

800mm / 32"

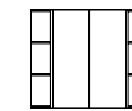

900mm / 36"

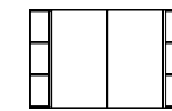

1200mm / 48"

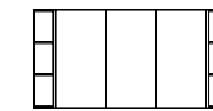

1500mm / 60"

Juniper Mirrored Cabinet



01.

Add storage to your bathroom while complementing your style with the Juniper mirrored cabinet. The side panels show a hint of your chosen color, adding a nice compliment to your vanity. Add under cabinet lighting for additional ambiance (additional charges apply).



[01.] Juniper Mirrored Cabinet 600mm / 24" | JUN-MC-24-W-SS | \$1,572 | Sunday Stroll Cabinet (Tier 1)

[02.] Juniper Mirrored Cabinet 800mm / 32" | JUN-MC-32-W-OS | \$1,905 | Olive Satin Cabinet (Tier 2)

[03.] Juniper Mirrored Cabinet 900mm / 36" | JUN-MC-36-W-RH | \$1,774 | Rhapsody Cabinet (Tier 1)

AVAILABLE COLOR RANGES



ANY TIER 1
WOODGRAIN LAMINATE



ANY TIER 2
WOOD VENEER



ANY TIER 2
PAINTED COLOR

AVAILABLE SIZES

760mm / 30"

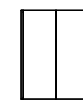

600mm / 24"

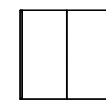

800mm / 32"

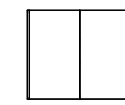

900mm / 36"

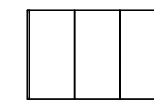

1200mm / 48"

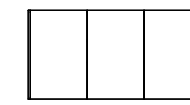

1500mm / 60"

Ridge Mirrored Cabinet



The Ridge mirrored cabinet is a stylish and practical way to add storage and space to your bathroom. It's design features a taller height than our other mirrored cabinets for more storage and mirror space. Add under cabinet lighting for additional ambiance (additional charges apply).



[01.] Ridge Mirrored Cabinet 600mm / 24" | RID-MC-24-W-SG | \$1,729 | Simply Gallant Cabinet (Tier 1)

[02.] Ridge Mirrored Cabinet 600mm / 24" | RID-MC-24-W-WG | \$1,729 | Weekend Getaway Cabinet (Tier 1)

[03.] Ridge Mirrored Cabinet 400mm / 24" | RID-MC-24-W-KC | \$1,729 | Kiss Curl Cabinet (Tier 1)

AVAILABLE COLOR RANGES



ANY TIER 1
WOODGRAIN LAMINATE



ANY TIER 2
WOOD VENEER



ANY TIER 2
PAINTED COLOR

AVAILABLE SIZES

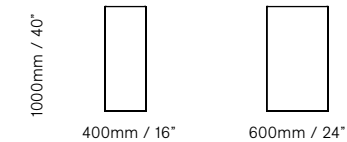

Sage Mirrored Cabinet



The Sage mirrored cabinet has similar features to the Juniper mirror cabinet but the mirror extends all the way to the cabinet sides. Choose any color option from our selection. Add under cabinet lighting for additional ambiance (additional charges apply).



[01.] Sage Mirrored Cabinet 1200mm / 48" | SAG-MC-48-W-RH | \$2,252 | Rhapsody Cabinet (Tier 1)

[02.] Sage Mirrored Cabinet 900mm / 36" | SAG-MC-36-W-BL | \$1,979 | Black Satin Cabinet (Tier 2)

AVAILABLE COLOR RANGES



ANY TIER 1
WOODGRAIN LAMINATE



ANY TIER 2
WOOD VENEER



ANY TIER 2
PAINTED COLOR

AVAILABLE SIZES

760mm / 30"

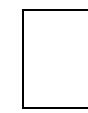

600mm / 24"

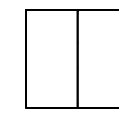

800mm / 32"

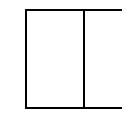

900mm / 36"

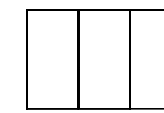

1200mm / 48"

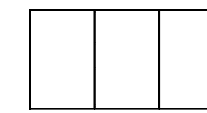

1500mm / 60"

Willow Mirrored Cabinet



The Willow mirrored cabinet includes storage options both behind the mirror and an open shelf below. One of our best sellers, the Willow makes a statement in any bathroom. Add in-shelf cabinet lighting for additional ambiance (additional charges apply).



- [01.] Willow Mirrored Cabinet 900mm / 36" | WIL-MC-36-W-KC | \$1,791 | Kiss Curl Cabinet (Tier 1)
- [02.] Willow Mirrored Cabinet 1200mm / 48" | WIL-MC-48-W-BL | \$2,520 | Black Satin Cabinet (Tier 2)
- [03.] Willow Mirrored Cabinet 800mm / 32" | WIL-MC-32-W-CL | \$1,936 | Chocolate Cabinet (Tier 2)

AVAILABLE COLOR RANGES

- 

ANY TIER 1
WOODGRAIN LAMINATE
- 

ANY TIER 2
WOOD VENEER
- 

ANY TIER 2
PAINTED COLOR

AVAILABLE SIZES

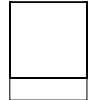
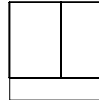
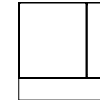
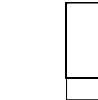
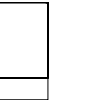
760mm / 30"					
	600mm / 24"	800mm / 32"	900mm / 36"	1200mm / 48"	1500mm / 60"

Floating Shelves



Perfect for displaying accessories in your new bathroom. Available in three practical sizes – 18", 21" and 24" with a standard depth of 8". Other sizes available on request (additional charges may apply). Includes hidden internal brackets for sturdy installation.



[01.] 3x Floating Shelves 525mm / 21" | FSH-S-21-W-CH | \$283 ea | Tete a Tete (Tier 1)

[02.] 3x Floating Shelves 450mm / 18" | FSH-S-18-W-SB | \$273 ea | Sheer Beauty (Tier 1)

AVAILABLE COLOR RANGES



ANY TIER 1
WOODGRAIN LAMINATE



ANY TIER 2
WOOD VENEER



ANY TIER 2
PAINTED COLOR

AVAILABLE SIZES





Linen Closets

- 42 Briar
- 43 Dune
- 44 Terra
- 45 Vale
- 46 Wren

Maren Vanity 36" MAR-V-36-C-QUA-W-OS-KNG-TQ-0-SQU | \$4,609. Juniper Mirrored Cabinet SAG-MC-36-W-OS | \$1,984. Briar Linen Closet BRI-LC-18-W-OS-KNG | \$3,109.



Briar Linen Closet



[01.] Briar Linen Closet 450mm / 18" | BRI-LC-18-F-SB-BP10G | \$2,842 | Sheer Beauty Cabinet (Tier 1) | Gold Bar Handle 10"

The Briar linen closet is perfect if you're looking to maximize storage in your bathroom. Its classic design makes it the ideal fit for all spaces. The door and drawer combination allows you to keep your items organized and out of sight. Includes two adjustable shelves, and a middle storage drawer.

AVAILABLE COLOR RANGES



AVAILABLE MOUNTING

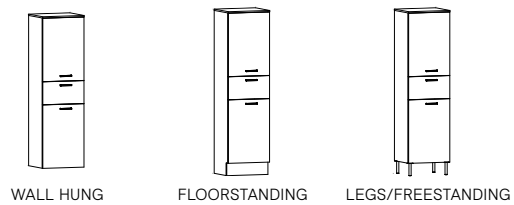

Dune Linen Closet



[01.] Dune Linen Closet 450mm / 18" | DUN-LC-18-W-DG-BP3N | \$3,432 | Dark Grey Satin Cabinet (Tier 2) | Nickel Bar Pulls 3"

Choose a Dune linen closet for maximum storage with the timeless and transitional look of shaker doors. Add under cabinet lighting for additional ambiance (additional charges apply). Includes two adjustable shelves, and a middle storage drawer. Designed to match our Kodiak Vanity, this linen closet is sure to make a statement in your bathroom.

AVAILABLE COLOR RANGES



AVAILABLE MOUNTING

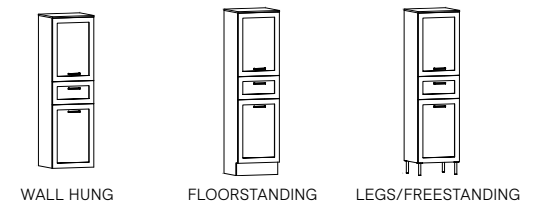

Terra Linen Closet



[01.] Terra Linen Closet 450mm / 18" | TER-LC-18-W-RH-PTO | \$1,906 | Rhapsody Cabinet (Tier 1) | Push-to-Open

The Terra linen closet gives you a full length mirror with masses of storage. Its Push-to-Open design means no handle interrupts the impressively useful long mirror.

AVAILABLE COLOR RANGES



AVAILABLE MOUNTING

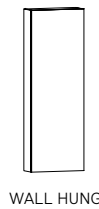

Vale Linen Closet



[01.] Vale Linen Closet 300mm / 12" | VAL-LC-12-W-BL-PTO | \$2,665 | Black Satin Cabinet (Tier 2) | Push-to-Open

The Vale linen closet is a small and sophisticated linen closet with Push-to-Open inset doors for a modern but timeless look. Add under cabinet lighting for additional ambiance (additional charges apply).

AVAILABLE COLOR RANGES



AVAILABLE MOUNTING

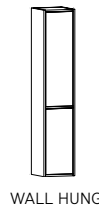

Wren Linen Closet



[01.] Wren Linen Closet 300mm / 12" | WRE-LC-12-W-SS-PTO | \$2,316 | Sunday Stroll Cabinet (Tier 1) | Push-to-Open

The Wren linen closet gives you options for your storage so you can display your favorite accessories with an open middle shelf. Choose any color option from our selection.

AVAILABLE COLOR RANGES

- 

ANY TIER 1
WOODGRAIN LAMINATE
- 

ANY TIER 2
WOOD VENEER
- 

ANY TIER 2
PAINTED COLOR

AVAILABLE MOUNTING

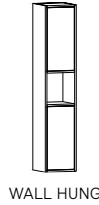

Looking for something a little different?



View our Stock Collection - Quick Ship Brochure!

www.timberlinebp.com



Kodiak Vanity 36" KOD-V-36-C-PEA-L-LG-KNB-1-STB | \$3,161. **Juniper Mirrored Cabinet** JUN-MC-36-W-LG | \$1,984.

Pricelist

- 51 Pricelist Guide
- 52 SKU Guide
- 54 Cullen
- 56 Finn
- 58 Kodiak
- 60 Linden
- 63 Maren
- 65 Tuscany
- 66 Vera
- 68 Wells
- 70 Wall-to-Wall
- 71 Isla Mirrored Cabinet
- 71 Juniper Mirrored Cabinet
- 72 Ridge Mirrored Cabinet
- 72 Sage Mirrored Cabinet
- 72 Willow Mirrored Cabinet
- 73 Floating Shelves
- 73 Briar Linen Closet
- 74 Dune Linen Closet
- 75 Terra Linen Closet
- 76 Vale Linen Closet
- 76 Wren Linen Closet

The following pricelist contains our suggested retail pricing for each of our standard vanity configurations and accessories as well as components that are available for separate purchase and upgrade options. This allows you to obtain an estimate on your choices. Pricing needs to be confirmed with a local dealer.



Keep up with the latest design trends!

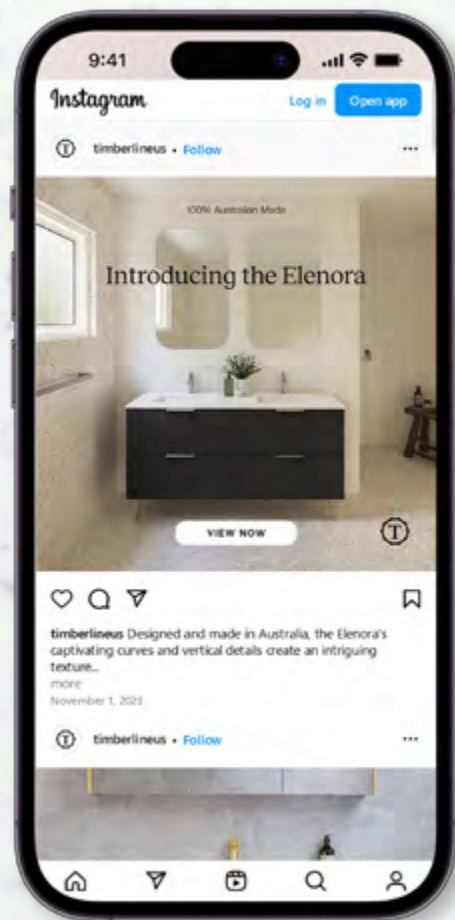

Follow us on social media



facebook.com/timberlineus



@timberlineus



@timberline-us

Pricelist Guide

Here is a quick guide on how to use this pricelist. Still have questions? Give our helpful staff a call at +1 888 844 0102.

Colors

Our pricing structure is based on 2 levels of colors. Each SKU is priced at two levels, **Tier 1** and **Tier 2**.

Tier 1: Woodgrain Laminates

Tier 2: Wood Veneer, Solid Colors, and Painted Colors

Additional Cost Options

Options such as cabinet customizing, filler panels and lighting are shown on page 78-81.

Cabinet or Top Only Orders

Where available, prices are shown for vanity cabinet only. Vanity top only prices are on page 86.

Prices

All prices are Manufacturer's Suggested Retail Price (MSRP). Check with your preferred store for exact pricing in your area.

How our SKUs work

Our SKU's have been designed to contain a lot of information on each cabinet, for more information, go to page 52-53.

No Cost Options

Additional no cost options available are:

- **Left or Right-Hand:** Cabinets may be ordered with left or right-hand configuration. Please specify when ordering.
- **Number of Faucet Holes:** Quartz, Silksurface, and Laminate tops are available with 0, 1, or 3 (widespread, or centerset) faucet holes. Peak and Crest Mineral Composite tops are available with 1 or 3 faucet holes.
- **Colors and Hardware:** Choose any of the colors or handles shown at the back of the brochure based on the pricing tier you choose.
- **Two Tone Cabinets:** Change up the look of your cabinet by choosing different colors for the front and sides of your cabinet.

Freight/Shipping Costs

Shipping costs are per item/SKU and based on your location. Orders with 3 or more items will ship free. Please consult with your showroom or store for specific shipping costs.



Vera Vanity 36" VER-V-36-C-CRE-W-BL-OVI3N-1 | \$2,565. Juniper Mirrored Cabinet JUN-MC-36-W-BL | \$1,979. Vale Linen Closet VAL-LC-12-W-BL-PTO | \$2,665

NOTE: All prices are Manufacturer's Suggested Retail Price (MSRP). Prices may vary depending on location and are subject to change or correction without notification. All information is provided on a E&OE (errors and omissions excepted) basis. There is a lot of very useful information in this brochure and there is more than likely an error, big or small, somewhere. Images in this brochure are shown with accessories and other furniture not included in the price or supplied by Timberline.

SKUs & How to Order

Here is a quick guide on how to order. There is 2 different ways to order, chose which ever method suits you better. Call us on 888-844-0102 with any questions on building a SKU, or on pricing.

Option 1 - Base SKU with Notes

Over the next pages, we provide SKUs with pricing. These SKUs reflect the cabinet, size, top, mount, and finish level. They do not include specifics such as color and hardware. You can order with these 'base' SKUs and add the rest of the information as a note in the PO.

Base SKU:

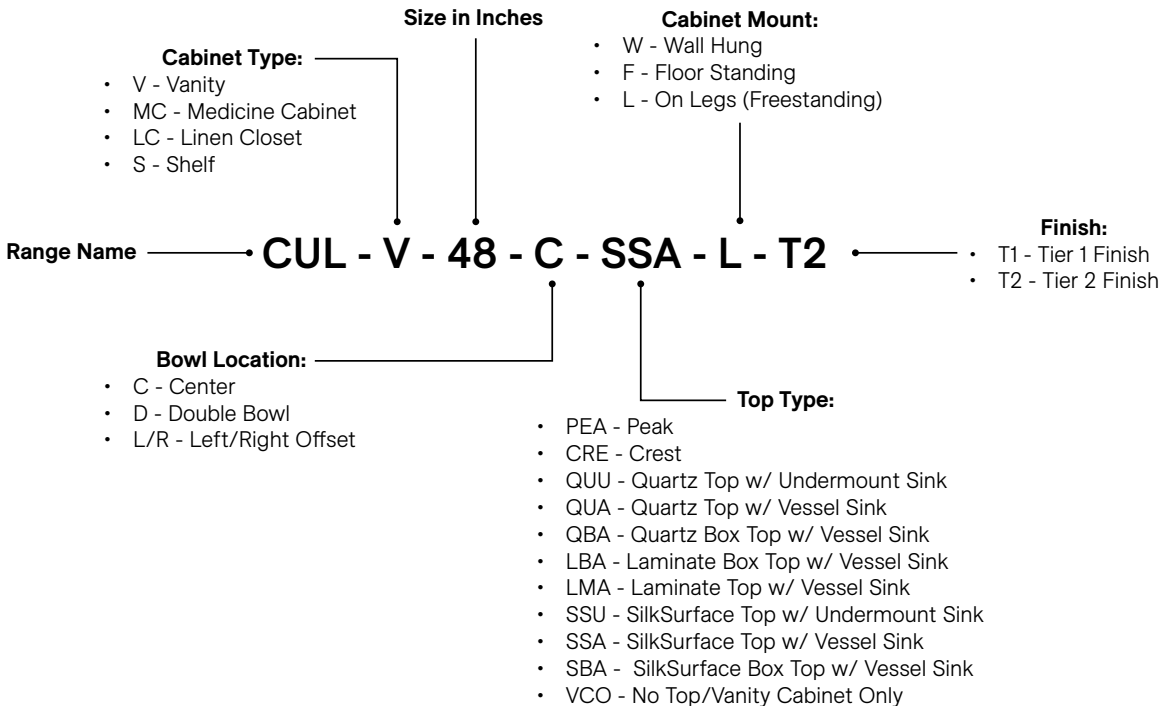

Example

To order with this method, Use the SKU in the pricelist page, and add notes to the PO with the following information. Not everything is required/applicable on every order, (e.g. if you are ordering a wall mount vanity, you obviously won't need leg style/color information, etc):

- Cabinet Color
- Top Color
- Hardware Style and Finish
- Faucet Hole Drilling
- Leg Style and Finish
- Sink Style (Vessel sink only)

If you want, you can use the order form on page 101 with this method as a way of getting down all the relevant information.

Option 2 - Fully built out SKUs

This option uses the base SKU, and adds all the information to it so you don't have to add notes to your PO. **Note:** all SKUs shown in this brochure under a product image are built out using this method.

Built out SKU:

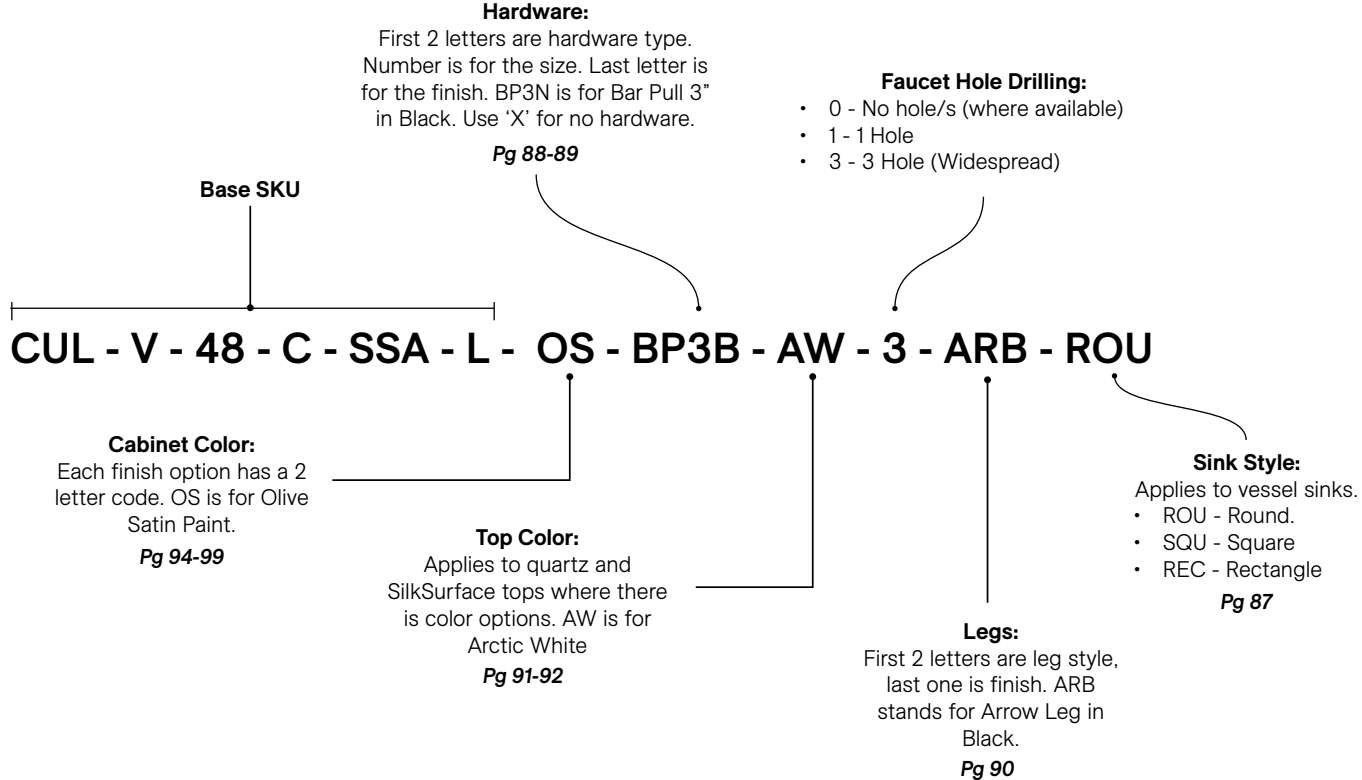

Example

To order with this method, Use the SKU in the pricelist page, and add to it, to create one long SKU. All the codes for cabinet colors, hardware, top colors, and legs, can be found in **-bold italics-** under the color name (example below)

Note: not all additional sections will be necessary for every vanity, leave out any that don't apply. E.g. a wall hung Cullen with a Peak top wouldn't need the legs, sink style, or top color section and would look like CUL-V-48-C-PEA-W-WH-BP3B-3.

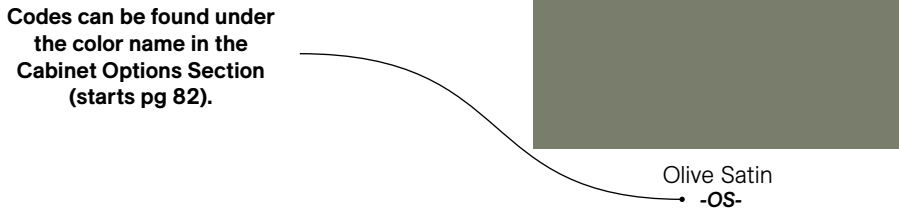

Cullen

CULLEN 600mm/24" SINGLE BOWL

Wall Hung

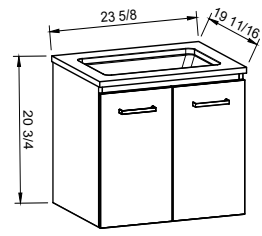

Floor Standing

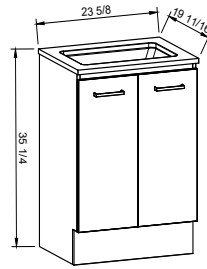

On Legs

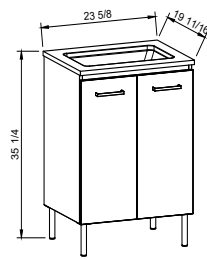

CABINET WITH	SKU	TIER 1 MSRP	TIER 2 MSRP
Peak/Crest Mineral Composite Top	CUL-V-24-C-PEA-W	\$2,067	\$2,143
SilkSurface with Above Counter Sink	CUL-V-24-C-SSA-W	\$2,918	\$3,070
SilkSurface with Undermount Sink	CUL-V-24-C-SSU-W	\$2,954	\$3,106
Quartz with Above Counter Sink	CUL-V-24-C-QUA-W	\$3,639	\$3,715
Quartz with Undermount Sink	CUL-V-24-C-QUU-W	\$3,675	\$3,751
Vanity Cabinet Only	CUL-V-24-C-VCO-W	\$1,729	\$1,804

CABINET WITH	SKU	TIER 1 MSRP	TIER 2 MSRP
Peak/Crest Mineral Composite Top	CUL-V-24-C-PEA-F	\$2,197	\$2,325
SilkSurface with Above Counter Sink	CUL-V-24-C-SSA-F	\$3,048	\$3,252
SilkSurface with Undermount Sink	CUL-V-24-C-SSU-F	\$3,084	\$3,288
Quartz with Above Counter Sink	CUL-V-24-C-QUA-F	\$3,769	\$3,897
Quartz with Undermount Sink	CUL-V-24-C-QUU-F	\$3,805	\$3,933
Vanity Cabinet Only	CUL-V-24-C-VCO-F	\$1,859	\$1,987

CABINET WITH	SKU	TIER 1 MSRP	TIER 2 MSRP
Peak/Crest Mineral Composite Top	CUL-V-24-C-PEA-L	\$2,197	\$2,325
SilkSurface with Above Counter Sink	CUL-V-24-C-SSA-L	\$3,048	\$3,252
SilkSurface with Undermount Sink	CUL-V-24-C-SSU-L	\$3,084	\$3,288
Quartz with Above Counter Sink	CUL-V-24-C-QUA-L	\$3,769	\$3,897
Quartz with Undermount Sink	CUL-V-24-C-QUU-L	\$3,805	\$3,933
Vanity Cabinet Only	CUL-V-24-C-VCO-L	\$1,859	\$1,987

CULLEN 800mm/32" SINGLE BOWL

Wall Hung

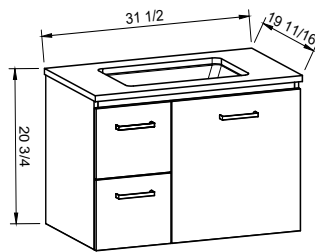

Floor Standing

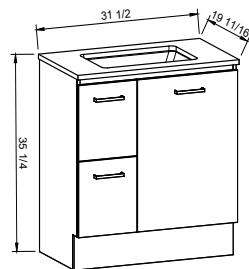

On Legs

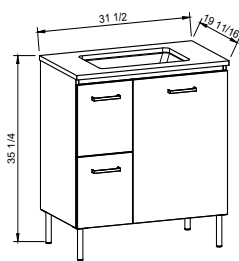

CABINET WITH	SKU	TIER 1 MSRP	TIER 2 MSRP
Peak/Crest Mineral Composite Top	CUL-V-32-C-PEA-W	\$2,495	\$2,581
SilkSurface with Above Counter Sink	CUL-V-32-C-SSA-W	\$3,566	\$3,728
SilkSurface with Undermount Sink	CUL-V-32-C-SSU-W	\$3,602	\$3,764
Quartz with Above Counter Sink	CUL-V-32-C-QUA-W	\$4,326	\$4,412
Quartz with Undermount Sink	CUL-V-32-C-QUU-W	\$4,362	\$4,448
Vanity Cabinet Only	CUL-V-32-C-VCO-W	\$2,101	\$2,187

CABINET WITH	SKU	TIER 1 MSRP	TIER 2 MSRP
Peak/Crest Mineral Composite Top	CUL-V-32-C-PEA-F	\$2,914	\$3,060
SilkSurface with Above Counter Sink	CUL-V-32-C-SSA-F	\$3,985	\$4,207
SilkSurface with Undermount Sink	CUL-V-32-C-SSU-F	\$4,021	\$4,243
Quartz with Above Counter Sink	CUL-V-32-C-QUA-F	\$4,746	\$4,891
Quartz with Undermount Sink	CUL-V-32-C-QUU-F	\$4,782	\$4,927
Vanity Cabinet Only	CUL-V-32-C-VCO-F	\$2,520	\$2,666

CABINET WITH	SKU	TIER 1 MSRP	TIER 2 MSRP
Peak/Crest Mineral Composite Top	CUL-V-32-C-PEA-L	\$2,914	\$3,060
SilkSurface with Above Counter Sink	CUL-V-32-C-SSA-L	\$3,985	\$4,207
SilkSurface with Undermount Sink	CUL-V-32-C-SSU-L	\$4,021	\$4,243
Quartz with Above Counter Sink	CUL-V-32-C-QUA-L	\$4,746	\$4,891
Quartz with Undermount Sink	CUL-V-32-C-QUU-L	\$4,782	\$4,927
Vanity Cabinet Only	CUL-V-32-C-VCO-L	\$2,520	\$2,666

NOTE: For Crest Mineral Composite tops, depth is shallower (18 1/8"). See page 86 for detailed top sizes.

Cullen

CULLEN 900mm/36" SINGLE BOWL

Wall Hung

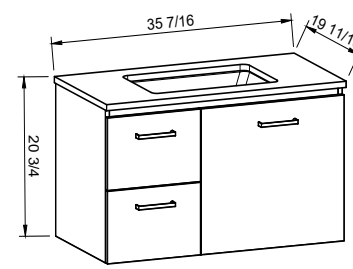

Floor Standing

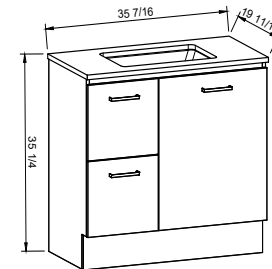

On Legs

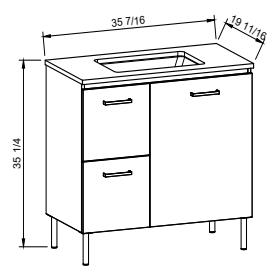

CABINET WITH	SKU	TIER 1 MSRP	TIER 2 MSRP
Peak/Crest Mineral Composite Top	CUL-V-36-C-PEA-W	\$2,618	\$2,709
SilkSurface with Above Counter Sink	CUL-V-36-C-SSA-W	\$3,753	\$3,920
SilkSurface with Undermount Sink	CUL-V-36-C-SSU-W	\$3,789	\$3,956
Quartz with Above Counter Sink	CUL-V-36-C-QUA-W	\$4,518	\$4,609
Quartz with Undermount Sink	CUL-V-36-C-QUU-W	\$4,555	\$4,645
Vanity Cabinet Only	CUL-V-36-C-VCO-W	\$2,150	\$2,241

CABINET WITH	SKU	TIER 1 MSRP	TIER 2 MSRP
Peak/Crest Mineral Composite Top	CUL-V-36-C-PEA-F	\$3,059	\$3,214
SilkSurface with Above Counter Sink	CUL-V-36-C-SSA-F	\$4,194	\$4,426
SilkSurface with Undermount Sink	CUL-V-36-C-SSU-F	\$4,230	\$4,462
Quartz with Above Counter Sink	CUL-V-36-C-QUA-F	\$4,959	\$5,114
Quartz with Undermount Sink	CUL-V-36-C-QUU-F	\$4,995	\$5,151
Vanity Cabinet Only	CUL-V-36-C-VCO-F	\$2,591	\$2,746

CABINET WITH	SKU	TIER 1 MSRP	TIER 2 MSRP
Peak/Crest Mineral Composite Top	CUL-V-36-C-PEA-L	\$3,059	\$3,214
SilkSurface with Above Counter Sink	CUL-V-36-C-SSA-L	\$4,194	\$4,426
SilkSurface with Undermount Sink	CUL-V-36-C-SSU-L	\$4,230	\$4,462
Quartz with Above Counter Sink	CUL-V-36-C-QUA-L	\$4,959	\$5,114
Quartz with Undermount Sink	CUL-V-36-C-QUU-L	\$4,995	\$5,151
Vanity Cabinet Only	CUL-V-36-C-VCO-L	\$2,591	\$2,746

CULLEN 1200mm/48" SINGLE BOWL

Wall Hung

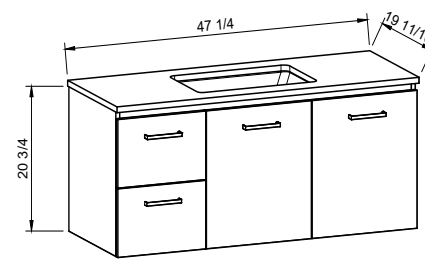

Floor Standing

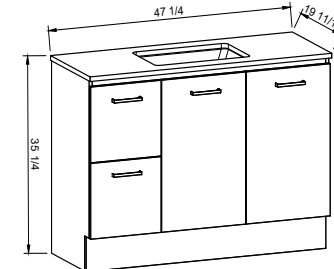

On Legs

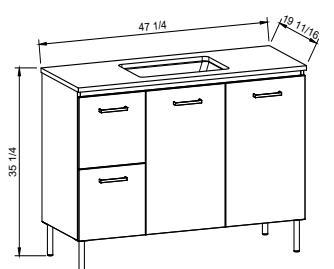

CABINET WITH	SKU	TIER 1 MSRP	TIER 2 MSRP
Peak/Crest Mineral Composite Top	CUL-V-48-C-PEA-W	\$3,312	\$3,420
SilkSurface with Above Counter Sink	CUL-V-48-C-SSA-W	\$4,534	\$4,741
SilkSurface with Undermount Sink	CUL-V-48-C-SSU-W	\$4,570	\$4,777
Quartz with Above Counter Sink	CUL-V-48-C-QUA-W	\$5,580	\$5,688
Quartz with Undermount Sink	CUL-V-48-C-QUU-W	\$5,616	\$5,725
Vanity Cabinet Only	CUL-V-48-C-VCO-W	\$2,753	\$2,861

CABINET WITH	SKU	TIER 1 MSRP	TIER 2 MSRP
Peak/Crest Mineral Composite Top	CUL-V-48-C-PEA-F	\$3,835	\$4,108
SilkSurface with Above Counter Sink	CUL-V-48-C-SSA-F	\$5,057	\$5,339
SilkSurface with Undermount Sink	CUL-V-48-C-SSU-F	\$5,093	\$5,375
Quartz with Above Counter Sink	CUL-V-48-C-QUA-F	\$6,103	\$6,322
Quartz with Undermount Sink	CUL-V-48-C-QUU-F	\$6,139	\$6,322
Vanity Cabinet Only	CUL-V-48-C-VCO-F	\$3,276	\$3,459

CABINET WITH	SKU	TIER 1 MSRP	TIER 2 MSRP
Peak/Crest Mineral Composite Top	CUL-V-48-C-PEA-L	\$3,835	\$4,108
SilkSurface with Above Counter Sink	CUL-V-48-C-SSA-L	\$5,057	\$5,339
SilkSurface with Undermount Sink	CUL-V-48-C-SSU-L	\$5,093	\$5,375
Quartz with Above Counter Sink	CUL-V-48-C-QUA-L	\$6,103	\$6,322
Quartz with Undermount Sink	CUL-V-48-C-QUU-L	\$6,139	\$6,322
Vanity Cabinet Only	CUL-V-48-C-VCO-L	\$3,276	\$3,459

NOTE: For Crest Mineral Composite tops, depth is shallower (18 1/8"). See page 86 for detailed top sizes.

Cullen

CULLEN 1500mm/60" DOUBLE BOWL

Wall Hung

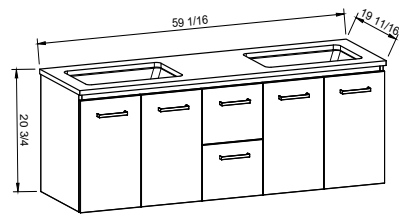

Floor Standing

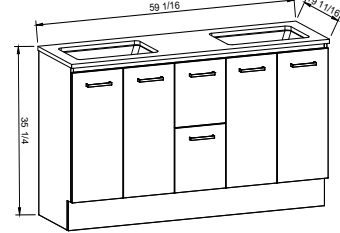

On Legs

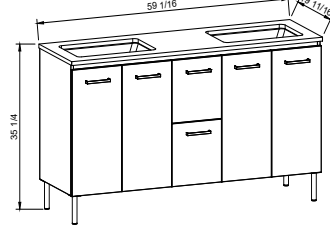

CABINET WITH	SKU	TIER 1 MSRP	TIER 2 MSRP
Peak/Crest Mineral Composite Top	CUL-V-60-D-PEA-W	\$4,258	\$4,377
SilkSurface with Above Counter Sinks	CUL-V-60-D-SSA-W	\$6,047	\$6,283
SilkSurface with Undermount Sinks	CUL-V-60-D-SSU-W	\$6,120	\$6,355
Quartz with Above Counter Sinks	CUL-V-60-D-QUA-W	\$7,741	\$7,861
Quartz with Undermount Sinks	CUL-V-60-D-QUU-W	\$7,814	\$7,933
Vanity Cabinet Only	CUL-V-60-D-VCO-W	\$3,491	\$3,610

CABINET WITH	SKU	TIER 1 MSRP	TIER 2 MSRP
Peak/Crest Mineral Composite Top	CUL-V-60-D-PEA-F	\$5,001	\$5,197
SilkSurface with Above Counter Sinks	CUL-V-60-D-SSA-F	\$6,791	\$7,102
SilkSurface with Undermount Sinks	CUL-V-60-D-SSU-F	\$6,863	\$7,174
Quartz with Above Counter Sinks	CUL-V-60-D-QUA-F	\$8,485	\$8,680
Quartz with Undermount Sinks	CUL-V-60-D-QUU-F	\$8,557	\$8,752
Vanity Cabinet Only	CUL-V-60-D-VCO-F	\$4,234	\$4,430

CABINET WITH	SKU	TIER 1 MSRP	TIER 2 MSRP
Peak/Crest Mineral Composite Top	CUL-V-60-D-PEA-L	\$5,001	\$5,197
SilkSurface with Above Counter Sinks	CUL-V-60-D-SSA-L	\$6,791	\$7,102
SilkSurface with Undermount Sinks	CUL-V-60-D-SSU-L	\$6,863	\$7,174
Quartz with Above Counter Sinks	CUL-V-60-D-QUA-L	\$8,485	\$8,680
Quartz with Undermount Sinks	CUL-V-60-D-QUU-L	\$8,557	\$8,752
Vanity Cabinet Only	CUL-V-60-D-VCO-L	\$4,234	\$4,430

Finn

FINN 600mm/24" SINGLE BOWL

Wall Hung

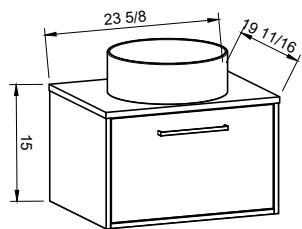

CABINET WITH	SKU	TIER 1 MSRP
16mm Laminate Top With Above Counter Sink	FIN-V-24-C-LMA-W	\$2,129
Vanity Cabinet Only	FIN-V-24-C-VCO-W	\$1,656

Floor Standing

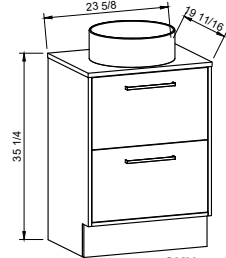

CABINET WITH	SKU	TIER 1 MSRP
16mm Laminate Top With Above Counter Sink	FIN-V-24-C-LMA-F	\$2,698
Vanity Cabinet Only	FIN-V-24-C-VCO-F	\$2,225

FINN 800mm/32" SINGLE BOWL

Wall Hung

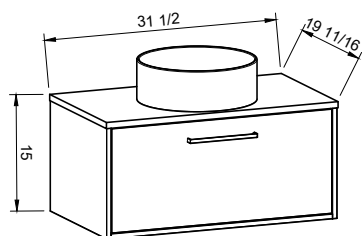

CABINET WITH	SKU	TIER 1 MSRP
16mm Laminate Top With Above Counter Sink	FIN-V-32-C-LMA-W	\$2,419
Vanity Cabinet Only	FIN-V-32-C-VCO-W	\$1,930

Floor Standing

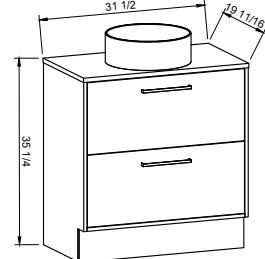

CABINET WITH	SKU	TIER 1 MSRP
16mm Laminate Top With Above Counter Sink	FIN-V-32-C-LMA-F	\$2,925
Vanity Cabinet Only	FIN-V-32-C-VCO-F	\$2,441

NOTE: For Finn - Tops only available in woodgrain laminate finishes. Drawer front/s and cabinet sides may be matching laminate or any other finish.

Finn

FINN 900mm/36" SINGLE BOWL

Wall Hung

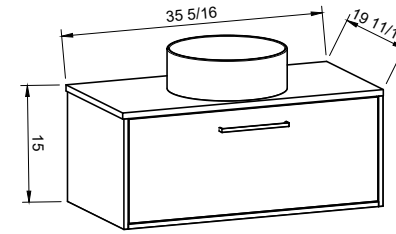

CABINET WITH	SKU	TIER 1 MSRP
16mm Laminate Top With Above Counter Sink	FIN-V-36-C-LMA-W	\$2,473
Vanity Cabinet Only	FIN-V-36-C-VCO-W	\$1,979

Floor Standing

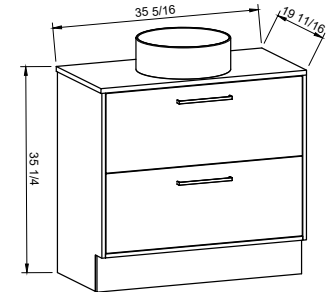

CABINET WITH	SKU	TIER 1 MSRP
16mm Laminate Top With Above Counter Sink	FIN-V-36-C-LMA-F	\$3,008
Vanity Cabinet Only	FIN-V-36-C-VCO-F	\$2,521

FINN 1200mm/48" SINGLE BOWL

Wall Hung

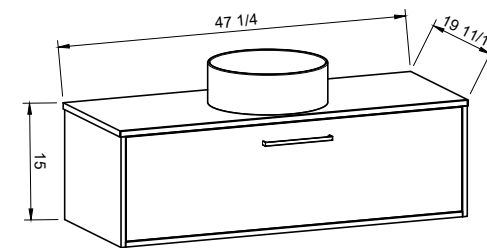

CABINET WITH	SKU	TIER 1 MSRP
16mm Laminate Top With Above Counter Sink	FIN-V-48-C-LMA-W	\$3,036
Vanity Cabinet Only	FIN-V-48-C-VCO-W	\$2,531

Floor Standing

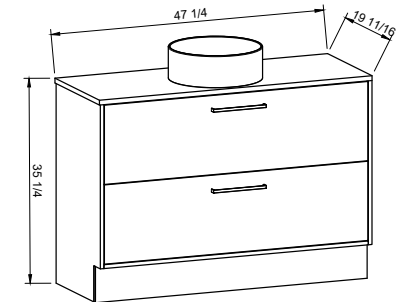

CABINET WITH	SKU	TIER 1 MSRP
16mm Laminate Top With Above Counter Sink	FIN-V-48-C-LMA-F	\$3,613
Vanity Cabinet Only	FIN-V-48-C-VCO-F	\$3,097

FINN 1500mm/60" DOUBLE BOWL

Wall Hung

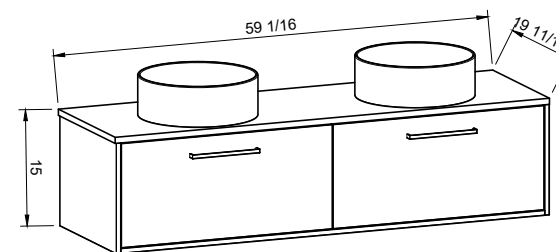

CABINET WITH	SKU	TIER 1 MSRP
16mm Laminate Top With Above Counter Sinks	FIN-V-60-D-LMA-W	\$3,630
Vanity Cabinet Only	FIN-V-60-D-VCO-W	\$2,739

Floor Standing

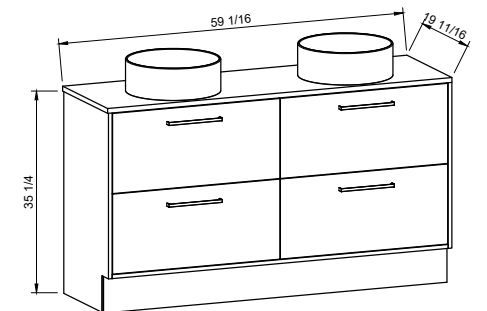

CABINET WITH	SKU	TIER 1 MSRP
16mm Laminate Top With Above Counter Sinks	FIN-V-60-D-LMA-F	\$4,863
Vanity Cabinet Only	FIN-V-60-D-VCO-F	\$3,943

NOTE: For Finn - Tops only available in woodgrain laminate finishes. Drawer front/s and cabinet sides may be matching laminate or any other finish.

Kodiak

KODIAK 600mm/24" SINGLE BOWL

Wall Hung

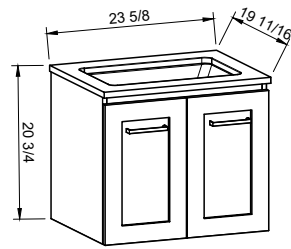

Floor Standing

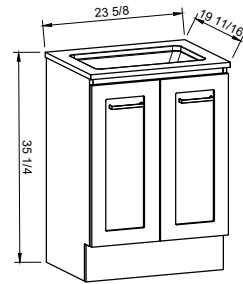

On Legs

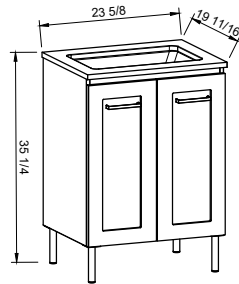

CABINET WITH	SKU	TIER 2 MSRP
Peak/Crest Mineral Composite Top	KOD-V-24-C-PEA-W	\$2,160
SilkSurface with Above Counter Sink	KOD-V-24-C-SSA-W	\$2,994
SilkSurface with Undermount Sink	KOD-V-24-C-SSU-W	\$3,030
Quartz with Above Counter Sink	KOD-V-24-C-QUA-W	\$3,732
Quartz with Undermount Sink	KOD-V-24-C-QUU-W	\$3,768
Vanity Cabinet Only	KOD-V-24-C-VCO-W	\$1,822

CABINET WITH	SKU	TIER 2 MSRP
Peak/Crest Mineral Composite Top	KOD-V-24-C-PEA-F	\$2,290
SilkSurface with Above Counter Sink	KOD-V-24-C-SSA-F	\$3,124
SilkSurface with Undermount Sink	KOD-V-24-C-SSU-F	\$3,160
Quartz with Above Counter Sink	KOD-V-24-C-QUA-F	\$3,862
Quartz with Undermount Sink	KOD-V-24-C-QUU-F	\$3,898
Vanity Cabinet Only	KOD-V-24-C-VCO-F	\$1,952

CABINET WITH	SKU	TIER 2 MSRP
Peak/Crest Mineral Composite Top	KOD-V-24-C-PEA-L	\$2,290
SilkSurface with Above Counter Sink	KOD-V-24-C-SSA-L	\$3,124
SilkSurface with Undermount Sink	KOD-V-24-C-SSU-L	\$3,160
Quartz with Above Counter Sink	KOD-V-24-C-QUA-L	\$3,862
Quartz with Undermount Sink	KOD-V-24-C-QUU-L	\$3,898
Vanity Cabinet Only	KOD-V-24-C-VCO-L	\$1,952

KODIAK 800mm/32" SINGLE BOWL

Wall Hung

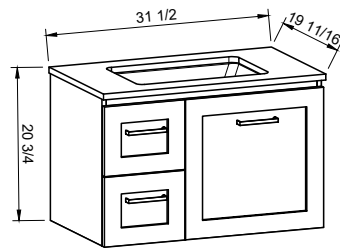

Floor Standing

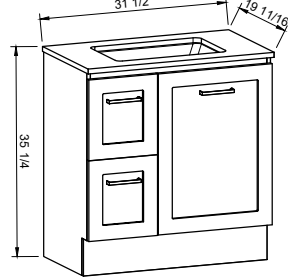

On Legs

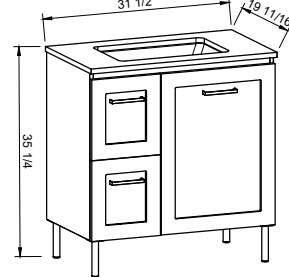

CABINET WITH	SKU	TIER 2 MSRP
Peak/Crest Mineral Composite Top	KOD-V-32-C-PEA-W	\$2,594
SilkSurface with Above Counter Sink	KOD-V-32-C-SSA-W	\$3,642
SilkSurface with Undermount Sink	KOD-V-32-C-SSU-W	\$3,678
Quartz with Above Counter Sink	KOD-V-32-C-QUA-W	\$4,425
Quartz with Undermount Sink	KOD-V-32-C-QUU-W	\$4,461
Vanity Cabinet Only	KOD-V-32-C-VCO-W	\$2,200

CABINET WITH	SKU	TIER 2 MSRP
Peak/Crest Mineral Composite Top	KOD-V-32-C-PEA-F	\$3,013
SilkSurface with Above Counter Sink	KOD-V-32-C-SSA-F	\$4,062
SilkSurface with Undermount Sink	KOD-V-32-C-SSU-F	\$4,098
Quartz with Above Counter Sink	KOD-V-32-C-QUA-F	\$4,844
Quartz with Undermount Sink	KOD-V-32-C-QUU-F	\$4,880
Vanity Cabinet Only	KOD-V-32-C-VCO-F	\$2,619

CABINET WITH	SKU	TIER 2 MSRP
Peak/Crest Mineral Composite Top	KOD-V-32-C-PEA-L	\$3,013
SilkSurface with Above Counter Sink	KOD-V-32-C-SSA-L	\$4,062
SilkSurface with Undermount Sink	KOD-V-32-C-SSU-L	\$4,098
Quartz with Above Counter Sink	KOD-V-32-C-QUA-L	\$4,844
Quartz with Undermount Sink	KOD-V-32-C-QUU-L	\$4,880
Vanity Cabinet Only	KOD-V-32-C-VCO-L	\$2,619

NOTE: For Crest Mineral Composite tops, depth is shallower (18 1/8"). See page 86 for detailed top sizes.

Kodiak

KODIAK 900mm/36" SINGLE BOWL

Wall Hung

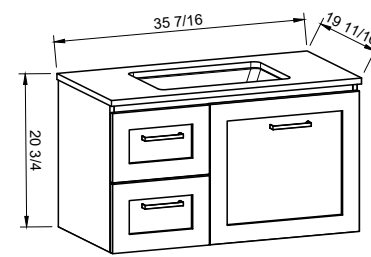

Floor Standing

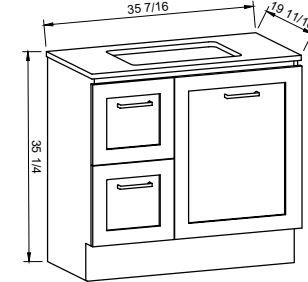

On Legs

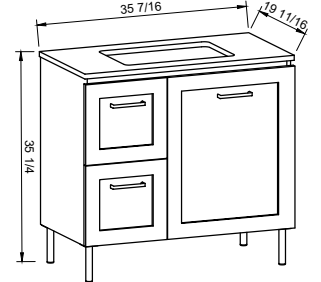

CABINET WITH	SKU	TIER 2 MSRP
Peak/Crest Mineral Composite Top	KOD-V-36-C-PEA-W	\$2,720
SilkSurface with Above Counter Sink	KOD-V-36-C-SSA-W	\$3,830
SilkSurface with Undermount Sink	KOD-V-36-C-SSU-W	\$3,866
Quartz with Above Counter Sink	KOD-V-36-C-QUA-W	\$4,620
Quartz with Undermount Sink	KOD-V-36-C-QUU-W	\$4,656
Vanity Cabinet Only	KOD-V-36-C-VCO-W	\$2,252

CABINET WITH	SKU	TIER 2 MSRP
Peak/Crest Mineral Composite Top	KOD-V-36-C-PEA-F	\$3,161
SilkSurface with Above Counter Sink	KOD-V-36-C-SSA-F	\$4,270
SilkSurface with Undermount Sink	KOD-V-36-C-SSU-F	\$4,306
Quartz with Above Counter Sink	KOD-V-36-C-QUA-F	\$5,061
Quartz with Undermount Sink	KOD-V-36-C-QUU-F	\$5,097
Vanity Cabinet Only	KOD-V-36-C-VCO-F	\$2,693

CABINET WITH	SKU	TIER 2 MSRP
Peak/Crest Mineral Composite Top	KOD-V-36-C-PEA-L	\$3,161
SilkSurface with Above Counter Sink	KOD-V-36-C-SSA-L	\$4,270
SilkSurface with Undermount Sink	KOD-V-36-C-SSU-L	\$4,306
Quartz with Above Counter Sink	KOD-V-36-C-QUA-L	\$5,061
Quartz with Undermount Sink	KOD-V-36-C-QUU-L	\$5,097
Vanity Cabinet Only	KOD-V-36-C-VCO-L	\$2,693

KODIAK 1200mm/48" SINGLE BOWL

Wall Hung

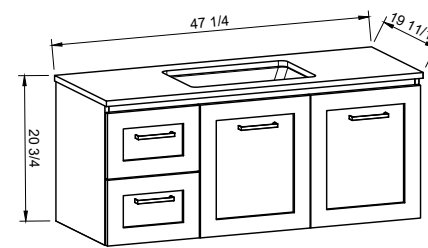

Floor Standing

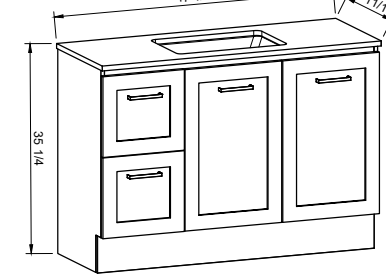

On Legs

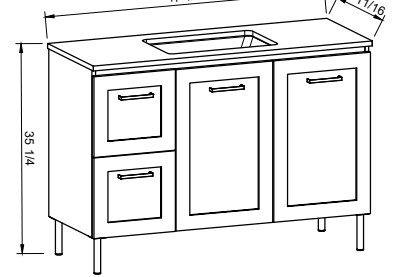

CABINET WITH	SKU	TIER 2 MSRP
Peak/Crest Mineral Composite Top	KOD-V-48-C-PEA-W	\$3,444
SilkSurface with Above Counter Sink	KOD-V-48-C-SSA-W	\$4,633
SilkSurface with Undermount Sink	KOD-V-48-C-SSU-W	\$4,669
Quartz with Above Counter Sink	KOD-V-48-C-QUA-W	\$5,712
Quartz with Undermount Sink	KOD-V-48-C-QUU-W	\$5,748
Vanity Cabinet Only	KOD-V-48-C-VCO-W	\$2,885

CABINET WITH	SKU	TIER 2 MSRP
Peak/Crest Mineral Composite Top	KOD-V-48-C-PEA-F	\$3,967
SilkSurface with Above Counter Sink	KOD-V-48-C-SSA-F	\$5,156
SilkSurface with Undermount Sink	KOD-V-48-C-SSU-F	\$5,192
Quartz with Above Counter Sink	KOD-V-48-C-QUA-F	\$6,235
Quartz with Undermount Sink	KOD-V-48-C-QUU-F	\$6,272
Vanity Cabinet Only	KOD-V-48-C-VCO-F	\$3,408

CABINET WITH	SKU	TIER 2 MSRP
Peak/Crest Mineral Composite Top	KOD-V-48-C-PEA-L	\$3,967
SilkSurface with Above Counter Sink	KOD-V-48-C-SSA-L	\$5,156
SilkSurface with Undermount Sink	KOD-V-48-C-SSU-L	\$5,192
Quartz with Above Counter Sink	KOD-V-48-C-QUA-L	\$6,235
Quartz with Undermount Sink	KOD-V-48-C-QUU-L	\$6,272
Vanity Cabinet Only	KOD-V-48-C-VCO-L	\$3,408

NOTE: For Crest Mineral Composite tops, depth is shallower (18 1/8"). See page 86 for detailed top sizes.

Kodiak

KODIAK 1500mm/60" DOUBLE BOWL

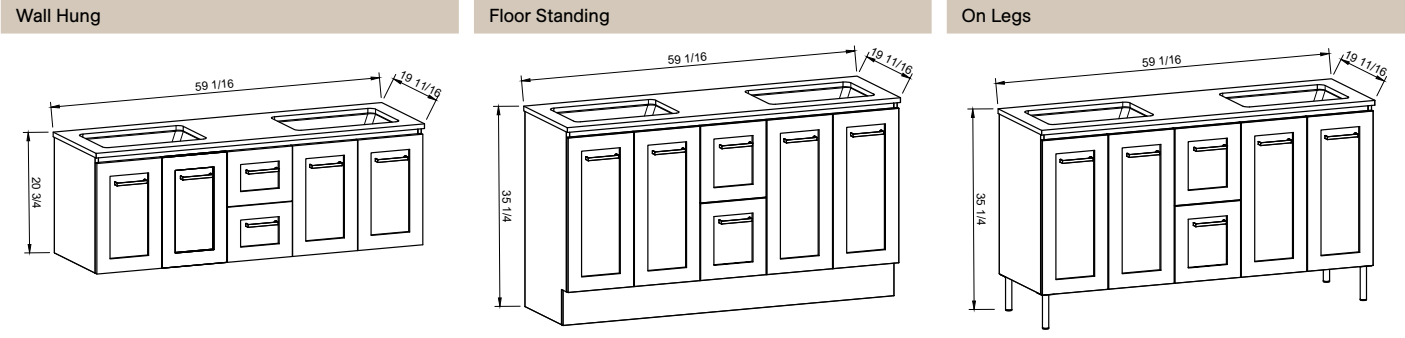

CABINET WITH	SKU	TIER 2 MSRP	CABINET WITH	SKU	TIER 2 MSRP	CABINET WITH	SKU	TIER 2 MSRP
Peak/Crest Mineral Composite Top	KOD-V-60-D-PEA-W	\$4,416	Peak/Crest Mineral Composite Top	KOD-V-60-D-PEA-F	\$5,159	Peak/Crest Mineral Composite Top	KOD-V-60-D-PEA-L	\$5,159
SilkSurface with Above Counter Sinks	KOD-V-60-D-SSA-W	\$6,163	SilkSurface with Above Counter Sinks	KOD-V-60-D-SSA-F	\$6,907	SilkSurface with Above Counter Sinks	KOD-V-60-D-SSA-L	\$6,907
SilkSurface with Undermount Sinks	KOD-V-60-D-SSU-W	\$6,236	SilkSurface with Undermount Sinks	KOD-V-60-D-SSU-F	\$6,979	SilkSurface with Undermount Sinks	KOD-V-60-D-SSU-L	\$6,979
Quartz with Above Counter Sinks	KOD-V-60-D-QUA-W	\$7,899	Quartz with Above Counter Sinks	KOD-V-60-D-QUA-F	\$8,642	Quartz with Above Counter Sinks	KOD-V-60-D-QUA-L	\$8,642
Quartz with Undermount Sinks	KOD-V-60-D-QUU-W	\$7,971	Quartz with Undermount Sinks	KOD-V-60-D-QUU-F	\$8,714	Quartz with Undermount Sinks	KOD-V-60-D-QUU-L	\$8,714
Vanity Cabinet Only	KOD-V-60-D-VCO-W	\$3,649	Vanity Cabinet Only	KOD-V-60-D-VCO-F	\$4,392	Vanity Cabinet Only	KOD-V-60-D-VCO-L	\$4,392

Linden

LINDEN 600mm/24" SINGLE BOWL

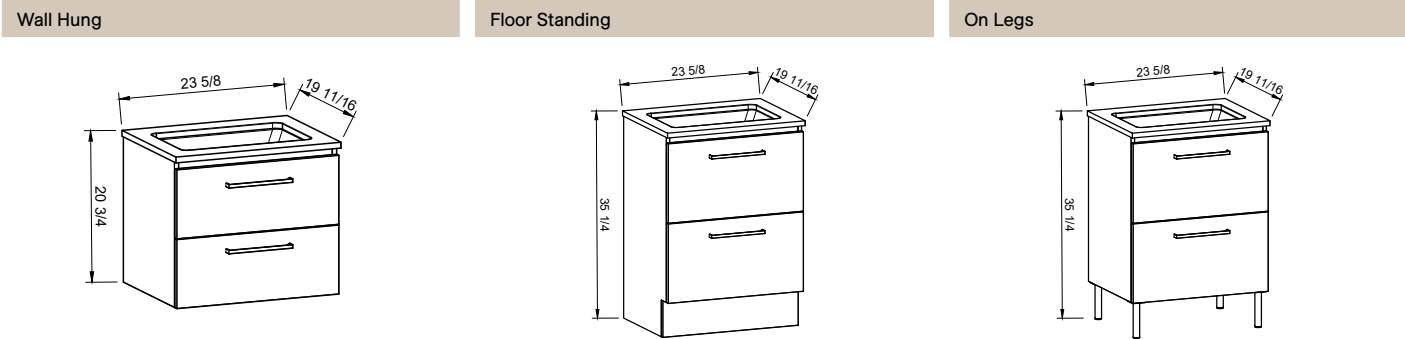

CABINET WITH	SKU	TIER 1 MSRP	TIER 2 MSRP	CABINET WITH	SKU	TIER 1 MSRP	TIER 2 MSRP	CABINET WITH	SKU	TIER 1 MSRP	TIER 2 MSRP
Peak/Crest Mineral Composite Top	LIN-V-24-C-PEA-W	\$2,290	\$2,366	Peak/Crest Mineral Composite Top	LIN-V-24-C-PEA-F	\$2,614	\$2,744	Peak/Crest Mineral Composite Top	LIN-V-24-C-PEA-L	\$2,614	\$2,744
SilkSurface with Above Counter Sink	LIN-V-24-C-SSA-W	\$3,141	\$3,293	SilkSurface with Above Counter Sink	LIN-V-24-C-SSA-F	\$3,465	\$3,671	SilkSurface with Above Counter Sink	LIN-V-24-C-SSA-L	\$3,465	\$3,671
SilkSurface with Undermount Sink	LIN-V-24-C-SSU-W	\$3,177	\$3,329	SilkSurface with Undermount Sink	LIN-V-24-C-SSU-F	\$3,501	\$3,707	SilkSurface with Undermount Sink	LIN-V-24-C-SSU-L	\$3,501	\$3,707
Quartz with Above Counter Sink	LIN-V-24-C-QUA-W	\$3,862	\$3,938	Quartz with Above Counter Sink	LIN-V-24-C-QUA-F	\$4,186	\$4,316	Quartz with Above Counter Sink	LIN-V-24-C-QUA-L	\$4,186	\$4,316
Quartz with Undermount Sink	LIN-V-24-C-QUU-W	\$3,898	\$3,974	Quartz with Undermount Sink	LIN-V-24-C-QUU-F	\$4,222	\$4,352	Quartz with Undermount Sink	LIN-V-24-C-QUU-L	\$4,222	\$4,352
Vanity Cabinet Only	LIN-V-24-C-VCO-L	\$1,952	\$2,028	Vanity Cabinet Only	LIN-V-24-C-VCO-F	\$2,276	\$2,406	Vanity Cabinet Only	LIN-V-24-C-VCO-L	\$2,276	\$2,406

NOTE: For Crest Mineral Composite tops, depth is shallower (18 1/8"). See page 86 for detailed top sizes.

Linden

LINDEN 800mm/32" SINGLE BOWL

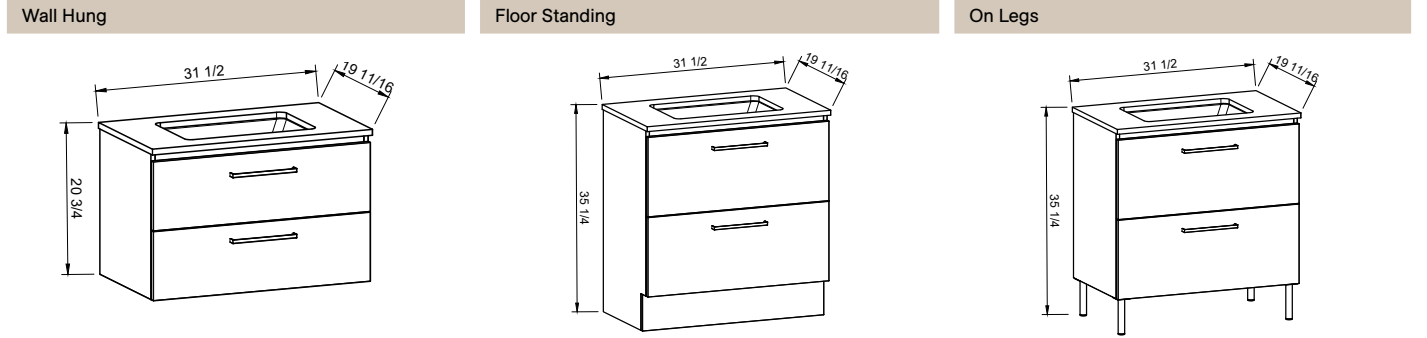

CABINET WITH	SKU	TIER 1 MSRP	TIER 2 MSRP	CABINET WITH	SKU	TIER 1 MSRP	TIER 2 MSRP	CABINET WITH	SKU	TIER 1 MSRP	TIER 2 MSRP
Peak/Crest Mineral Composite Top	LIN-V-32-C-PEA-W	\$2,482	\$2,568	Peak/Crest Mineral Composite Top	LIN-V-32-C-PEA-F	\$2,861	\$3,007	Peak/Crest Mineral Composite Top	LIN-V-32-C-PEA-L	\$2,861	\$3,007
SilkSurface with Above Counter Sink	LIN-V-32-C-SSA-W	\$3,553	\$3,715	SilkSurface with Above Counter Sink	LIN-V-32-C-SSA-F	\$3,931	\$4,155	SilkSurface with Above Counter Sink	LIN-V-32-C-SSA-L	\$3,931	\$4,155
SilkSurface with Undermount Sink	LIN-V-32-C-SSU-W	\$3,589	\$3,751	SilkSurface with Undermount Sink	LIN-V-32-C-SSU-F	\$3,968	\$4,191	SilkSurface with Undermount Sink	LIN-V-32-C-SSU-L	\$3,968	\$4,191
Quartz with Above Counter Sink	LIN-V-32-C-QUA-W	\$4,313	\$4,399	Quartz with Above Counter Sink	LIN-V-32-C-QUA-F	\$4,692	\$4,839	Quartz with Above Counter Sink	LIN-V-32-C-QUA-L	\$4,692	\$4,839
Quartz with Undermount Sink	LIN-V-32-C-QUU-W	\$4,349	\$4,435	Quartz with Undermount Sink	LIN-V-32-C-QUU-F	\$4,728	\$4,875	Quartz with Undermount Sink	LIN-V-32-C-QUU-L	\$4,728	\$4,875
Vanity Cabinet Only	LIN-V-32-C-VCO-L	\$2,088	\$2,174	Vanity Cabinet Only	LIN-V-32-C-VCO-F	\$2,467	\$2,613	Vanity Cabinet Only	LIN-V-32-C-VCO-L	\$2,467	\$2,613

LINDEN 900mm/36" SINGLE BOWL

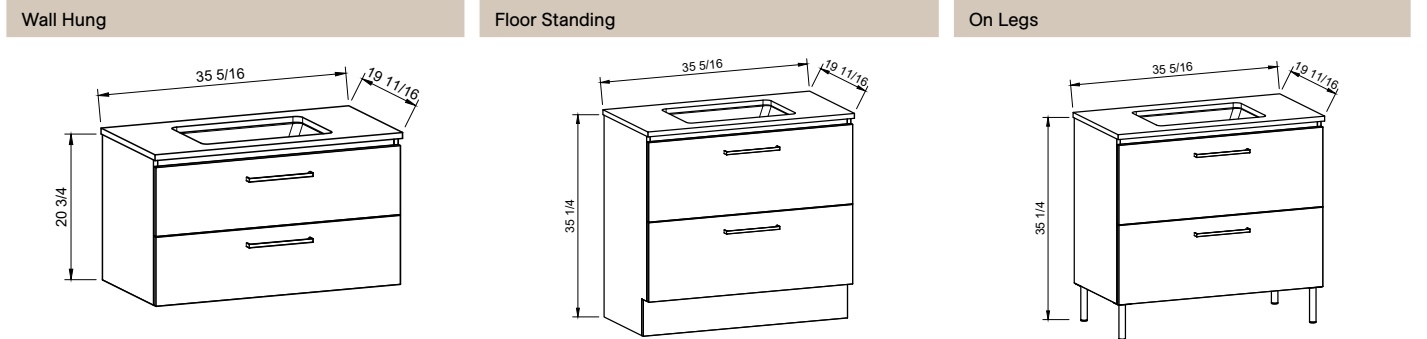

CABINET WITH	SKU	TIER 1 MSRP	TIER 2 MSRP	CABINET WITH	SKU	TIER 1 MSRP	TIER 2 MSRP	CABINET WITH	SKU	TIER 1 MSRP	TIER 2 MSRP
Peak/Crest Mineral Composite Top	LIN-V-36-C-PEA-W	\$2,624	\$2,715	Peak/Crest Mineral Composite Top	LIN-V-36-C-PEA-F	\$3,006	\$3,161	Peak/Crest Mineral Composite Top	LIN-V-36-C-PEA-L	\$3,006	\$3,161
SilkSurface with Above Counter Sink	LIN-V-36-C-SSA-W	\$3,758	\$3,926	SilkSurface with Above Counter Sink	LIN-V-36-C-SSA-F	\$4,140	\$4,372	SilkSurface with Above Counter Sink	LIN-V-36-C-SSA-L	\$4,140	\$4,372
SilkSurface with Undermount Sink	LIN-V-36-C-SSU-W	\$3,795	\$3,962	SilkSurface with Undermount Sink	LIN-V-36-C-SSU-F	\$4,176	\$4,408	SilkSurface with Undermount Sink	LIN-V-36-C-SSU-L	\$4,176	\$4,408
Quartz with Above Counter Sink	LIN-V-36-C-QUA-W	\$4,524	\$4,615	Quartz with Above Counter Sink	LIN-V-36-C-QUA-F	\$4,906	\$5,061	Quartz with Above Counter Sink	LIN-V-36-C-QUA-L	\$4,906	\$5,061
Quartz with Undermount Sink	LIN-V-36-C-QUU-W	\$4,560	\$4,651	Quartz with Undermount Sink	LIN-V-36-C-QUU-F	\$4,942	\$5,097	Quartz with Undermount Sink	LIN-V-36-C-QUU-L	\$4,942	\$5,097
Vanity Cabinet Only	LIN-V-36-C-VCO-L	\$2,156	\$2,247	Vanity Cabinet Only	LIN-V-36-C-VCO-F	\$2,537	\$2,693	Vanity Cabinet Only	LIN-V-36-C-VCO-L	\$2,537	\$2,693

NOTE: For Crest Mineral Composite tops, depth is shallower (18 1/8"). See page 86 for detailed top sizes.

Linden

LINDEN 1200mm/48" SINGLE BOWL

Wall Hung

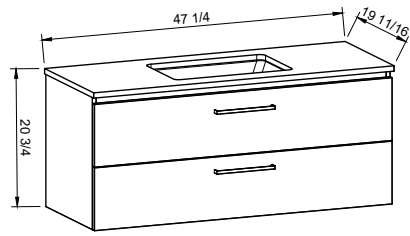

CABINET WITH	SKU	TIER 1 MSRP	TIER 2 MSRP
Peak/Crest Mineral Composite Top	LIN-V-48-C-PEA-W	\$3,241	\$3,349
SilkSurface with Above Counter Sink	LIN-V-48-C-SSA-W	\$4,463	\$4,670
SilkSurface with Undermount Sink	LIN-V-48-C-SSU-W	\$4,499	\$4,706
Quartz with Above Counter Sink	LIN-V-48-C-QUA-W	\$5,510	\$5,618
Quartz with Undermount Sink	LIN-V-48-C-QUU-W	\$5,546	\$5,654
Vanity Cabinet Only	LIN-V-48-C-VCO-W	\$2,682	\$2,790

Floor Standing

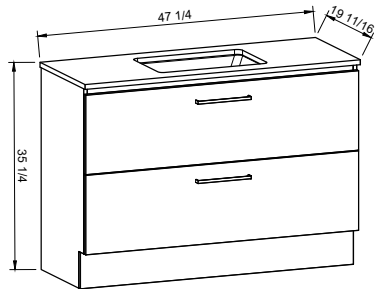

CABINET WITH	SKU	TIER 1 MSRP	TIER 2 MSRP
Peak/Crest Mineral Composite Top	LIN-V-48-C-PEA-F	\$3,686	\$3,869
SilkSurface with Above Counter Sink	LIN-V-48-C-SSA-F	\$4,908	\$5,190
SilkSurface with Undermount Sink	LIN-V-48-C-SSU-F	\$4,944	\$5,226
Quartz with Above Counter Sink	LIN-V-48-C-QUA-F	\$5,954	\$6,137
Quartz with Undermount Sink	LIN-V-48-C-QUU-F	\$5,990	\$6,173
Vanity Cabinet Only	LIN-V-48-C-VCO-F	\$3,127	\$3,310

On Legs

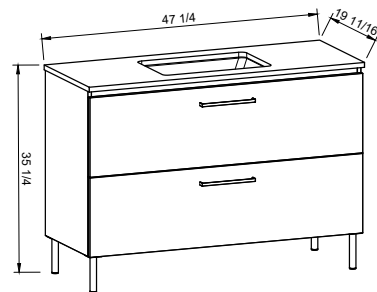

CABINET WITH	SKU	TIER 1 MSRP	TIER 2 MSRP
Peak/Crest Mineral Composite Top	LIN-V-48-C-PEA-L	\$3,686	\$3,869
SilkSurface with Above Counter Sink	LIN-V-48-C-SSA-L	\$4,908	\$5,190
SilkSurface with Undermount Sink	LIN-V-48-C-SSU-L	\$4,944	\$5,226
Quartz with Above Counter Sink	LIN-V-48-C-QUA-L	\$5,954	\$6,137
Quartz with Undermount Sink	LIN-V-48-C-QUU-L	\$5,990	\$6,173
Vanity Cabinet Only	LIN-V-48-C-VCO-L	\$3,127	\$3,310

LINDEN 1500mm/60" DOUBLE BOWL

Wall Hung

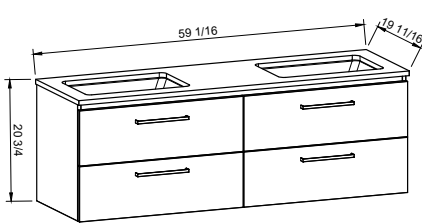

CABINET WITH	SKU	TIER 1 MSRP	TIER 2 MSRP
Peak/Crest Mineral Composite Top	LIN-V-60-D-PEA-W	\$4,195	\$4,316
SilkSurface with Above Counter Sinks	LIN-V-60-D-SSA-W	\$5,984	\$6,221
SilkSurface with Undermount Sinks	LIN-V-60-D-SSU-W	\$6,057	\$6,294
Quartz with Above Counter Sinks	LIN-V-60-D-QUA-W	\$7,678	\$7,799
Quartz with Undermount Sinks	LIN-V-60-D-QUU-W	\$7,751	\$7,872
Vanity Cabinet Only	LIN-V-60-D-VCO-W	\$3,428	\$3,549

Floor Standing

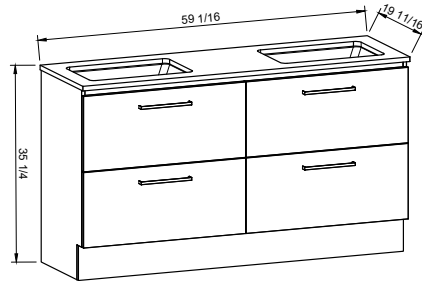

CABINET WITH	SKU	TIER 1 MSRP	TIER 2 MSRP
Peak/Crest Mineral Composite Top	LIN-V-60-D-PEA-F	\$4,753	\$4,959
SilkSurface with Above Counter Sinks	LIN-V-60-D-SSA-F	\$6,542	\$6,865
SilkSurface with Undermount Sinks	LIN-V-60-D-SSU-F	\$6,614	\$6,937
Quartz with Above Counter Sinks	LIN-V-60-D-QUA-F	\$8,236	\$8,443
Quartz with Undermount Sinks	LIN-V-60-D-QUU-F	\$8,308	\$8,515
Vanity Cabinet Only	LIN-V-60-D-VCO-F	\$3,986	\$4,192

On Legs

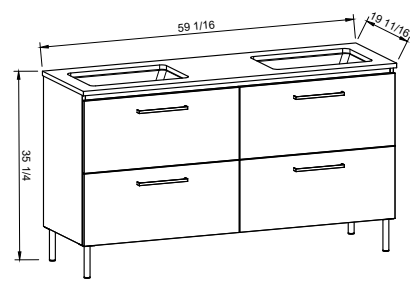

CABINET WITH	SKU	TIER 1 MSRP	TIER 2 MSRP
Peak/Crest Mineral Composite Top	LIN-V-60-D-PEA-L	\$4,753	\$4,959
SilkSurface with Above Counter Sinks	LIN-V-60-D-SSA-L	\$6,542	\$6,865
SilkSurface with Undermount Sinks	LIN-V-60-D-SSU-L	\$6,614	\$6,937
Quartz with Above Counter Sinks	LIN-V-60-D-QUA-L	\$8,236	\$8,443
Quartz with Undermount Sinks	LIN-V-60-D-QUU-L	\$8,308	\$8,515
Vanity Cabinet Only	LIN-V-60-D-VCO-L	\$3,986	\$4,192

NOTE: For Crest Mineral Composite tops, depth is shallower (18 1/8"). See page 86 for detailed top sizes.

Maren

MAREN 600mm/24" SINGLE BOWL

Wall Hung

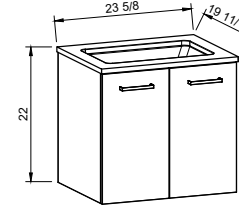

CABINET WITH	SKU	TIER 1 MSRP	TIER 2 MSRP
Peak/Crest Mineral Composite Top	MAR-V-24-C-PEA-W	\$2,067	\$2,143
SilkSurface with Above Counter Sink	MAR-V-24-C-SSA-W	\$2,918	\$3,070
SilkSurface with Undermount Sink	MAR-V-24-C-SSU-W	\$2,954	\$3,106
Quartz with Above Counter Sink	MAR-V-24-C-QUA-W	\$3,639	\$3,715
Quartz with Undermount Sink	MAR-V-24-C-QUU-W	\$3,675	\$3,751
Vanity Cabinet Only	MAR-V-24-C-VCO-W	\$1,729	\$1,804

MAREN 800mm/32" SINGLE BOWL

Wall Hung

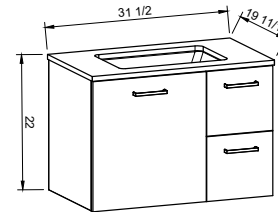

CABINET WITH	SKU	TIER 1 MSRP	TIER 2 MSRP
Peak/Crest Mineral Composite Top	MAR-V-32-C-PEA-W	\$2,495	\$2,581
SilkSurface with Above Counter Sink	MAR-V-32-C-SSA-W	\$3,566	\$3,728
SilkSurface with Undermount Sink	MAR-V-32-C-SSU-W	\$3,602	\$3,764
Quartz with Above Counter Sink	MAR-V-32-C-QUA-W	\$4,326	\$4,412
Quartz with Undermount Sink	MAR-V-32-C-QUU-W	\$4,362	\$4,448
Vanity Cabinet Only	MAR-V-32-C-VCO-W	\$2,101	\$2,187

MAREN 900mm/36" SINGLE BOWL

Wall Hung

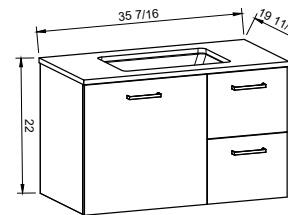

CABINET WITH	SKU	TIER 1 MSRP	TIER 2 MSRP
Peak/Crest Mineral Composite Top	MAR-V-36-C-PEA-W	\$2,618	\$2,709
SilkSurface with Above Counter Sink	MAR-V-36-C-SSA-W	\$3,753	\$3,920
SilkSurface with Undermount Sink	MAR-V-36-C-SSU-W	\$3,789	\$3,956
Quartz with Above Counter Sink	MAR-V-36-C-QUA-W	\$4,518	\$4,609
Quartz with Undermount Sink	MAR-V-36-C-QUU-W	\$4,555	\$4,645
Vanity Cabinet Only	MAR-V-36-C-VCO-W	\$2,150	\$2,241

Floor Standing

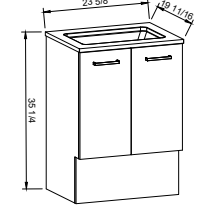

CABINET WITH	SKU	TIER 1 MSRP	TIER 2 MSRP
Peak/Crest Mineral Composite Top	MAR-V-24-C-PEA-F	\$2,197	\$2,325
SilkSurface with Above Counter Sink	MAR-V-24-C-SSA-F	\$3,048	\$3,252
SilkSurface with Undermount Sink	MAR-V-24-C-SSU-F	\$3,084	\$3,288
Quartz with Above Counter Sink	MAR-V-24-C-QUA-F	\$3,769	\$3,897
Quartz with Undermount Sink	MAR-V-24-C-QUU-F	\$3,805	\$3,933
Vanity Cabinet Only	MAR-V-24-C-VCO-F	\$1,859	\$1,987

Floor Standing

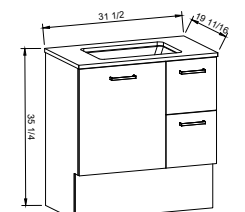

CABINET WITH	SKU	TIER 1 MSRP	TIER 2 MSRP
Peak/Crest Mineral Composite Top	MAR-V-32-C-PEA-F	\$2,914	\$3,060
SilkSurface with Above Counter Sink	MAR-V-32-C-SSA-F	\$3,985	\$4,207
SilkSurface with Undermount Sink	MAR-V-32-C-SSU-F	\$4,021	\$4,243
Quartz with Above Counter Sink	MAR-V-32-C-QUA-F	\$4,746	\$4,891
Quartz with Undermount Sink	MAR-V-32-C-QUU-F	\$4,782	\$4,927
Vanity Cabinet Only	MAR-V-32-C-VCO-F	\$2,520	\$2,666

Floor Standing

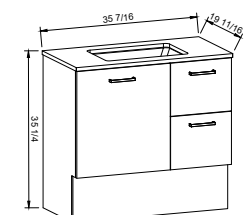

CABINET WITH	SKU	TIER 1 MSRP	TIER 2 MSRP
Peak/Crest Mineral Composite Top	MAR-V-36-C-PEA-F	\$3,059	\$3,214
SilkSurface with Above Counter Sink	MAR-V-36-C-SSA-F	\$4,194	\$4,426
SilkSurface with Undermount Sink	MAR-V-36-C-SSU-F	\$4,230	\$4,462
Quartz with Above Counter Sink	MAR-V-36-C-QUA-F	\$4,959	\$5,114
Quartz with Undermount Sink	MAR-V-36-C-QUU-F	\$4,995	\$5,151
Vanity Cabinet Only	MAR-V-36-C-VCO-F	\$2,591	\$2,746

Maren

MAREN 1200mm/48" SINGLE BOWL

Wall Hung

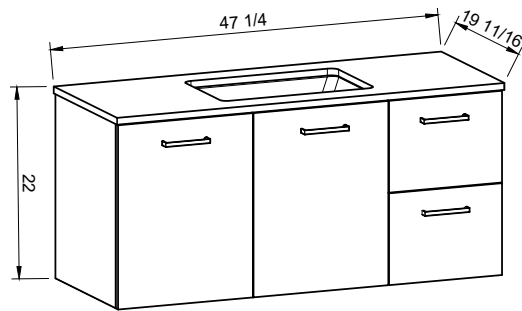

CABINET WITH	SKU	TIER 1 MSRP	TIER 2 MSRP
Peak/Crest Mineral Composite Top	MAR-V-48-C-PEA-W	\$3,312	\$3,420
SilkSurface with Above Counter Sink	MAR-V-48-C-SSA-W	\$4,534	\$4,741
SilkSurface with Undermount Sink	MAR-V-48-C-SSU-W	\$4,570	\$4,777
Quartz with Above Counter Sink	MAR-V-48-C-QUA-W	\$5,580	\$5,688
Quartz with Undermount Sink	MAR-V-48-C-QUU-W	\$5,616	\$5,725
Vanity Cabinet Only	MAR-V-48-C-VCO-W	\$2,753	\$2,861

MAREN 1500mm/60" DOUBLE BOWL

Wall Hung

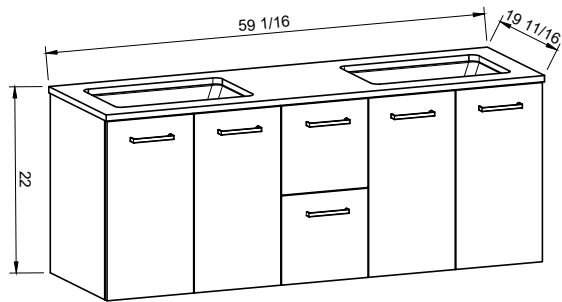

CABINET WITH	SKU	TIER 1 MSRP	TIER 2 MSRP
Peak/Crest Mineral Composite Top	MAR-V-60-D-PEA-W	\$4,258	\$4,377
SilkSurface with Above Counter Sinks	MAR-V-60-D-SSA-W	\$6,047	\$6,283
SilkSurface with Undermount Sinks	MAR-V-60-D-SSU-W	\$6,120	\$6,355
Quartz with Above Counter Sinks	MAR-V-60-D-QUA-W	\$7,741	\$7,861
Quartz with Undermount Sinks	MAR-V-60-D-QUU-W	\$7,814	\$7,933
Vanity Cabinet Only	MAR-V-60-D-VCO-W	\$3,491	\$3,610

Floor Standing

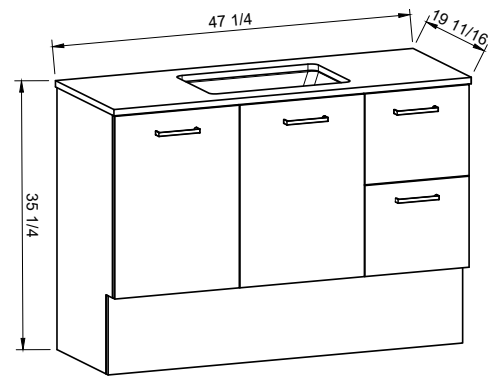

CABINET WITH	SKU	TIER 1 MSRP	TIER 2 MSRP
Peak/Crest Mineral Composite Top	MAR-V-48-C-PEA-F	\$3,835	\$4,018
SilkSurface with Above Counter Sink	MAR-V-48-C-SSA-F	\$5,057	\$5,339
SilkSurface with Undermount Sink	MAR-V-48-C-SSU-F	\$5,093	\$5,375
Quartz with Above Counter Sink	MAR-V-48-C-QUA-F	\$6,103	\$6,286
Quartz with Undermount Sink	MAR-V-48-C-QUU-F	\$6,139	\$6,322
Vanity Cabinet Only	MAR-V-48-C-VCO-F	\$3,276	\$3,459

Floor Standing

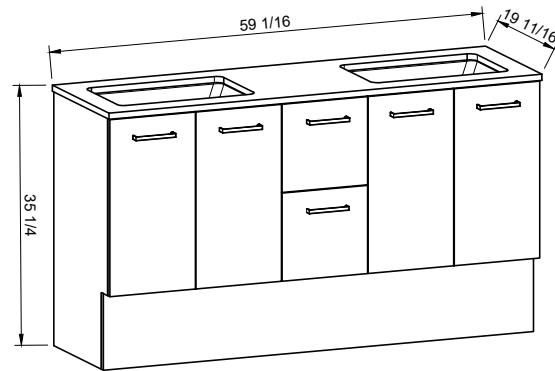

CABINET WITH	SKU	TIER 1 MSRP	TIER 2 MSRP
Peak/Crest Mineral Composite Top	MAR-V-60-D-PEA-F	\$5,001	\$5,197
SilkSurface with Above Counter Sinks	MAR-V-60-D-SSA-F	\$6,791	\$7,102
SilkSurface with Undermount Sinks	MAR-V-60-D-SSU-F	\$6,863	\$7,174
Quartz with Above Counter Sinks	MAR-V-60-D-QUA-F	\$8,485	\$8,680
Quartz with Undermount Sinks	MAR-V-60-D-QUU-F	\$8,557	\$8,752
Vanity Cabinet Only	MAR-V-60-D-VCO-F	\$4,234	\$4,430

NOTE: For Crest Mineral Composite tops, depth is shallower (18 1/8"). See page 86 for detailed top sizes.

Tuscany

TUSCANY 600mm/24" SINGLE BOWL

Wall Hung

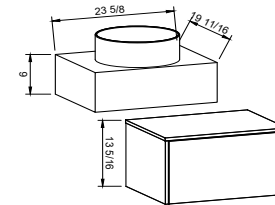

CABINET WITH	SKU	TIER 1 MSRP
Laminate Box Top w/ Above Counter Sink	TUS-V-24-C-LBA-W	\$4,068
Quartz Box Top w/ Above Counter Sink	TUS-V-24-C-QBA-W	\$4,973
Storage Cabinet Only	TUS-V-24-X-VCO-W	\$1,724

TUSCANY 900mm/36" SINGLE BOWL

Wall Hung

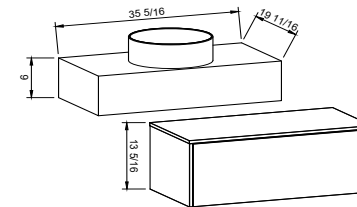

CABINET WITH	SKU	TIER 1 MSRP
Laminate Box Top w/ Above Counter Sink	TUS-V-36-C-LBA-W	\$4,996
Quartz Box Top w/ Above Counter Sink	TUS-V-36-C-QBA-W	\$5,972
Storage Cabinet Only	TUS-V-36-X-VCO-W	\$2,051

TUSCANY 1500mm/60" SINGLE BOWL

Wall Hung

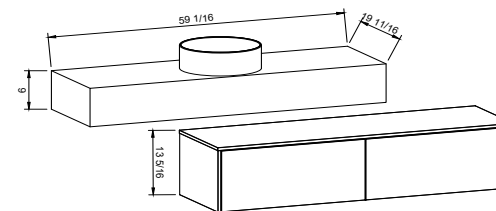

CABINET WITH	SKU	TIER 1 MSRP
Laminate Box Top w/ Above Counter Sink	TUS-V-60-C-LBA-W	\$6,953
Quartz Box Top w/ Above Counter Sink	TUS-V-60-C-QBA-W	\$8,077
Storage Cabinet Only	TUS-V-60-X-VCO-W	\$2,808

NOTE: For Tuscany - Tops only available in quartz and woodgrain laminate finishes. Woodgrain laminate only on storage cabinet top and sides, drawer front may be matching laminate or any other finish. Storage cabinet is Push-to-Open as standard. Handles available on request.

TUSCANY 800mm/32" SINGLE BOWL

Wall Hung

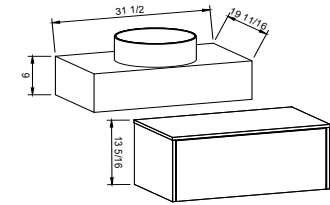

CABINET WITH	SKU	TIER 1 MSRP
Laminate Box Top w/ Above Counter Sink	TUS-V-32-C-LBA-W	\$4,644
Quartz Box Top w/ Above Counter Sink	TUS-V-32-C-QBA-W	\$5,590
Storage Cabinet Only	TUS-V-32-X-VCO-W	\$2,000

TUSCANY 1200mm/48" SINGLE BOWL

Wall Hung

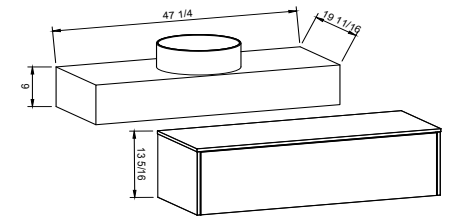

CABINET WITH	SKU	TIER 1 MSRP
Laminate Box Top w/ Above Counter Sink	TUS-V-48-C-LBA-W	\$5,932
Quartz Box Top w/ Above Counter Sink	TUS-V-48-C-QBA-W	\$6,863
Storage Cabinet Only	TUS-V-48-X-VCO-W	\$2,587

Vera

VERA 600mm/24" SINGLE BOWL

Wall Hung

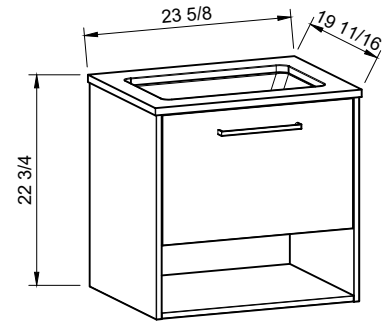

CABINET WITH	SKU	TIER 1 MSRP	TIER 2 MSRP
Peak/Crest Mineral Composite Top	VER-V-24-C-PEA-W	\$2,194	\$2,443
SilkSurface with Above Counter Sink	VER-V-24-C-SSA-W	\$3,045	\$3,277
SilkSurface with Undermount Sink	VER-V-24-C-SSU-W	\$3,081	\$3,313
Quartz with Above Counter Sink	VER-V-24-C-QUA-W	\$3,766	\$4,015
Quartz with Undermount Sink	VER-V-24-C-QUU-W	\$3,802	\$4,051
Vanity Cabinet Only	VER-V-24-C-VCO-W	\$1,856	\$2,104

Floor Standing

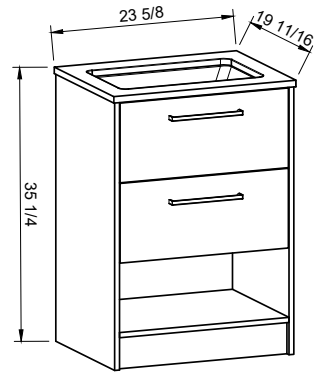

CABINET WITH	SKU	TIER 1 MSRP	TIER 2 MSRP
Peak/Crest Mineral Composite Top	VER-V-24-C-PEA-F	\$2,325	\$2,581
SilkSurface with Above Counter Sink	VER-V-24-C-SSA-F	\$3,176	\$3,415
SilkSurface with Undermount Sink	VER-V-24-C-SSU-F	\$3,212	\$3,451
Quartz with Above Counter Sink	VER-V-24-C-QUA-F	\$3,897	\$4,152
Quartz with Undermount Sink	VER-V-24-C-QUU-F	\$3,933	\$4,189
Vanity Cabinet Only	VER-V-24-C-VCO-F	\$1,987	\$2,242

VERA 800mm/32" SINGLE BOWL

Wall Hung

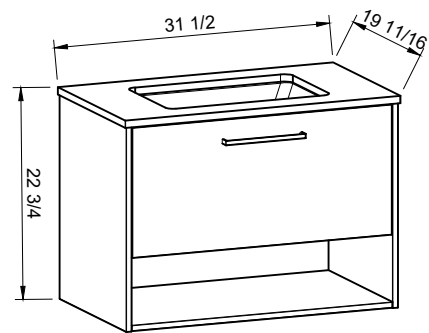

CABINET WITH	SKU	TIER 1 MSRP	TIER 2 MSRP
Peak/Crest Mineral Composite Top	VER-V-32-C-PEA-W	\$2,172	\$2,417
SilkSurface with Above Counter Sink	VER-V-32-C-SSA-W	\$3,243	\$3,465
SilkSurface with Undermount Sink	VER-V-32-C-SSU-W	\$3,279	\$3,502
Quartz with Above Counter Sink	VER-V-32-C-QUA-W	\$4,004	\$4,248
Quartz with Undermount Sink	VER-V-32-C-QUU-W	\$4,040	\$4,284
Vanity Cabinet Only	VER-V-32-C-VCO-W	\$1,778	\$2,023

Floor Standing

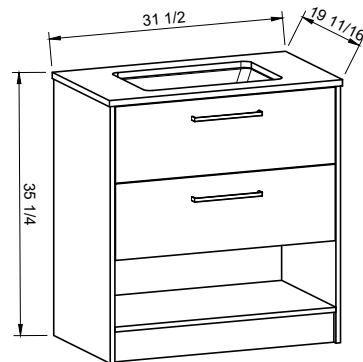

CABINET WITH	SKU	TIER 1 MSRP	TIER 2 MSRP
Peak/Crest Mineral Composite Top	VER-V-32-C-PEA-F	\$2,639	\$2,954
SilkSurface with Above Counter Sink	VER-V-32-C-SSA-F	\$3,710	\$4,003
SilkSurface with Undermount Sink	VER-V-32-C-SSU-F	\$3,746	\$4,039
Quartz with Above Counter Sink	VER-V-32-C-QUA-F	\$4,471	\$4,786
Quartz with Undermount Sink	VER-V-32-C-QUU-F	\$4,507	\$4,822
Vanity Cabinet Only	VER-V-32-C-VCO-F	\$2,245	\$2,560

NOTE: For Crest Mineral Composite tops, depth is shallower (18 1/8"). See page 86 for detailed top sizes.

Vera

VERA 900mm/36" SINGLE BOWL

Wall Hung

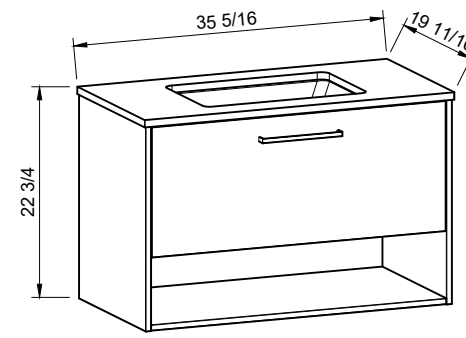

CABINET WITH	SKU	TIER 1 MSRP	TIER 2 MSRP
Peak/Crest Mineral Composite Top	VER-V-36-C-PEA-W	\$2,305	\$2,565
SilkSurface with Above Counter Sink	VER-V-36-C-SSA-W	\$3,440	\$3,675
SilkSurface with Undermount Sink	VER-V-36-C-SSU-W	\$3,476	\$3,711
Quartz with Above Counter Sink	VER-V-36-C-QUA-W	\$4,205	\$4,465
Quartz with Undermount Sink	VER-V-36-C-QUU-W	\$4,241	\$4,501
Vanity Cabinet Only	VER-V-36-C-VCO-W	\$1,837	\$2,097

Floor Standing

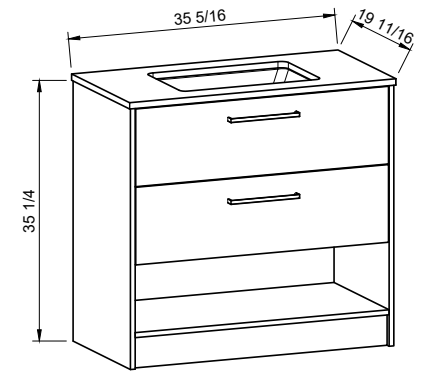

CABINET WITH	SKU	TIER 1 MSRP	TIER 2 MSRP
Peak/Crest Mineral Composite Top	VER-V-36-C-PEA-F	\$2,802	\$3,138
SilkSurface with Above Counter Sink	VER-V-36-C-SSA-F	\$3,937	\$4,248
SilkSurface with Undermount Sink	VER-V-36-C-SSU-F	\$3,937	\$4,284
Quartz with Above Counter Sink	VER-V-36-C-QUA-F	\$4,703	\$5,038
Quartz with Undermount Sink	VER-V-36-C-QUU-F	\$4,739	\$5,075
Vanity Cabinet Only	VER-V-36-C-VCO-F	\$2,334	\$2,670

VERA 1200mm/48" SINGLE BOWL

Wall Hung

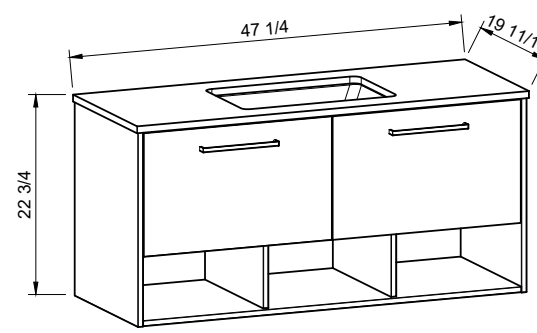

CABINET WITH	SKU	TIER 1 MSRP	TIER 2 MSRP
Peak/Crest Mineral Composite Top	VER-V-48-C-PEA-W	\$3,186	\$3,537
SilkSurface with Above Counter Sink	VER-V-48-C-SSA-W	\$4,408	\$4,726
SilkSurface with Undermount Sink	VER-V-48-C-SSU-W	\$4,444	\$4,762
Quartz with Above Counter Sink	VER-V-48-C-QUA-W	\$5,454	\$5,806
Quartz with Undermount Sink	VER-V-48-C-QUU-W	\$5,490	\$5,842
Vanity Cabinet Only	VER-V-48-C-VCO-W	\$2,627	\$2,979

Floor Standing

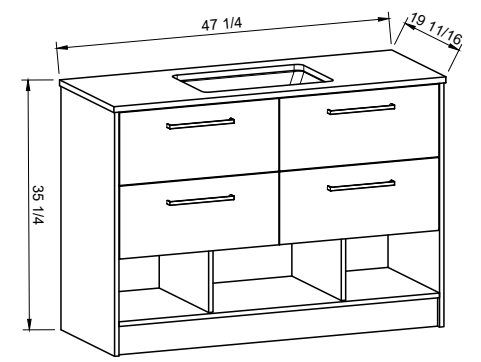

CABINET WITH	SKU	TIER 1 MSRP	TIER 2 MSRP
Peak/Crest Mineral Composite Top	VER-V-48-C-PEA-F	\$3,870	\$4,309
SilkSurface with Above Counter Sink	VER-V-48-C-SSA-F	\$5,092	\$5,498
SilkSurface with Undermount Sink	VER-V-48-C-SSU-F	\$5,129	\$5,534
Quartz with Above Counter Sink	VER-V-48-C-QUA-F	\$6,139	\$6,578
Quartz with Undermount Sink	VER-V-48-C-QUU-F	\$6,175	\$6,614
Vanity Cabinet Only	VER-V-48-C-VCO-F	\$3,311	\$3,750

NOTE: For Crest Mineral Composite tops, depth is shallower (18 1/8"). See page 86 for detailed top sizes.

Vera

VERA 1500mm/60" SINGLE BOWL

Wall Hung

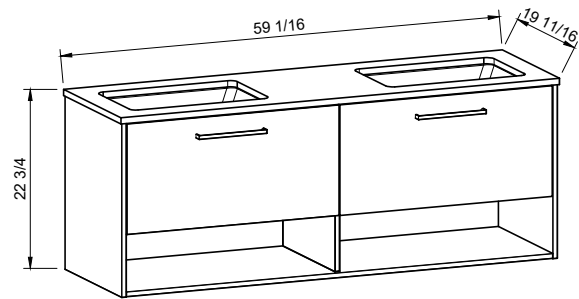

CABINET WITH	SKU	TIER 1 MSRP	TIER 2 MSRP
Peak/Crest Mineral Composite Top	VER-V-60-D-PEA-W	\$3,642	\$4,051
SilkSurface with Above Counter Sink	VER-V-60-D-SSA-W	\$5,432	\$5,799
SilkSurface with Undermount Sink	VER-V-60-D-SSU-W	\$5,504	\$5,871
Quartz with Above Counter Sink	VER-V-60-D-QUA-W	\$7,126	\$7,535
Quartz with Undermount Sink	VER-V-60-D-QUU-W	\$7,198	\$7,607
Vanity Cabinet Only	VER-V-60-D-VCO-W	\$2,875	\$3,285

Floor Standing

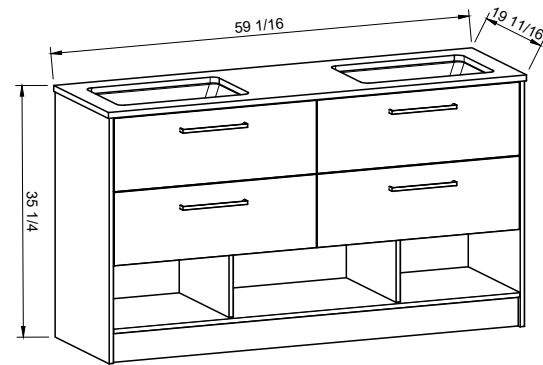

CABINET WITH	SKU	TIER 1 MSRP	TIER 2 MSRP
Peak/Crest Mineral Composite Top	VER-V-60-D-PEA-F	\$4,334	\$4,829
SilkSurface with Above Counter Sink	VER-V-60-D-SSA-F	\$6,124	\$6,577
SilkSurface with Undermount Sink	VER-V-60-D-SSU-F	\$6,196	\$6,649
Quartz with Above Counter Sink	VER-V-60-D-QUA-F	\$7,817	\$8,312
Quartz with Undermount Sink	VER-V-60-D-QUU-F	\$7,890	\$8,385
Vanity Cabinet Only	VER-V-60-D-VCO-F	\$3,567	\$4,062

Wells

WELLS 900mm/36" SINGLE BOWL

Wall Hung

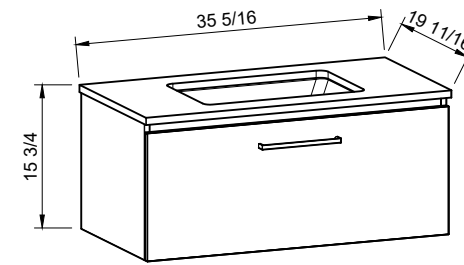

CABINET WITH	SKU	TIER 1 MSRP	TIER 2 MSRP
Peak/Crest Mineral Composite Top	WEL-V-36-C-PEA-W	\$2,500	\$2,671
SilkSurface with Above Counter Sink	WEL-V-36-C-SSA-W	\$3,635	\$3,781
SilkSurface with Undermount Sink	WEL-V-36-C-SSU-W	\$3,671	\$3,817
Quartz with Above Counter Sink	WEL-V-36-C-QUA-W	\$4,401	\$4,571
Quartz with Undermount Sink	WEL-V-36-C-QUU-W	\$4,437	\$4,607
Vanity Cabinet Only	WEL-V-36-C-VCO-W	\$2,032	\$2,203

WELLS 1200mm/48" SINGLE BOWL

Wall Hung

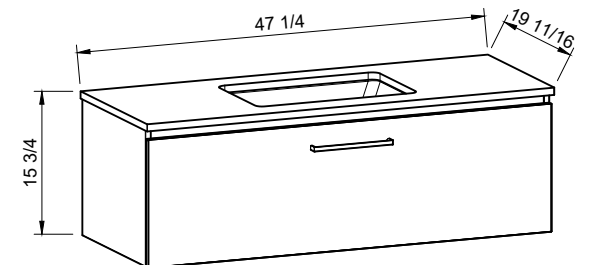

CABINET WITH	SKU	TIER 1 MSRP	TIER 2 MSRP
Peak/Crest Mineral Composite Top	WEL-V-48-C-PEA-W	\$3,142	\$3,354
SilkSurface with Above Counter Sink	WEL-V-48-C-SSA-W	\$4,364	\$4,543
SilkSurface with Undermount Sink	WEL-V-48-C-SSU-W	\$4,400	\$4,579
Quartz with Above Counter Sink	WEL-V-48-C-QUA-W	\$5,410	\$5,623
Quartz with Undermount Sink	WEL-V-48-C-QUU-W	\$5,446	\$5,659
Vanity Cabinet Only	WEL-V-48-C-VCO-W	\$2,583	\$2,796

Wells

WELLS 600mm/24" SINGLE BOWL

Wall Hung

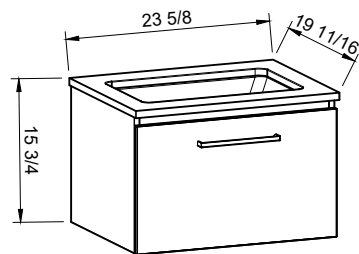

CABINET WITH	SKU	TIER 1 MSRP	TIER 2 MSRP
Peak/Crest Mineral Composite Top	WEL-V-24-C-PEA-W	\$2,032	\$2,182
SilkSurface with Above Counter Sink	WEL-V-24-C-SSA-W	\$2,883	\$3,016
SilkSurface with Undermount Sink	WEL-V-24-C-SSU-W	\$2,919	\$3,052
Quartz with Above Counter Sink	WEL-V-24-C-QUA-W	\$3,604	\$3,754
Quartz with Undermount Sink	WEL-V-24-C-QUU-W	\$3,640	\$3,790
Vanity Cabinet Only	WEL-V-24-C-VCO-W	\$1,694	\$1,844

WELLS 800mm/32" SINGLE BOWL

Wall Hung

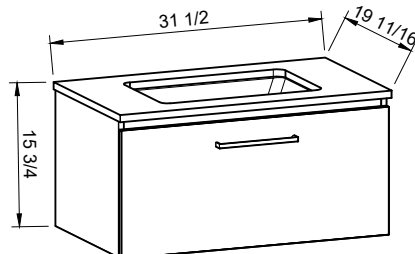

CABINET WITH	SKU	TIER 1 MSRP	TIER 2 MSRP
Peak/Crest Mineral Composite Top	WEL-V-32-C-PEA-W	\$2,377	\$2,541
SilkSurface with Above Counter Sink	WEL-V-32-C-SSA-W	\$3,448	\$3,589
SilkSurface with Undermount Sink	WEL-V-32-C-SSU-W	\$3,484	\$3,625
Quartz with Above Counter Sink	WEL-V-32-C-QUA-W	\$4,208	\$4,372
Quartz with Undermount Sink	WEL-V-32-C-QUU-W	\$4,244	\$4,408
Vanity Cabinet Only	WEL-V-32-C-VCO-W	\$1,983	\$2,147

WELLS 1500mm/60" DOUBLE BOWL

Wall Hung

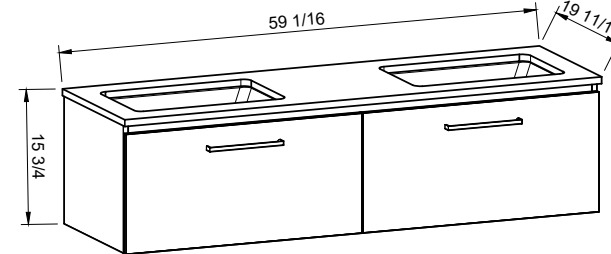

CABINET WITH	SKU	TIER 1 MSRP	TIER 2 MSRP
Peak/Crest Mineral Composite Top	WEL-V-60-D-PEA-W	\$3,567	\$3,817
SilkSurface with Above Counter Sink	WEL-V-60-D-SSA-W	\$5,357	\$5,565
SilkSurface with Undermount Sink	WEL-V-60-D-SSU-W	\$5,429	\$5,637
Quartz with Above Counter Sinks	WEL-V-60-D-QUA-W	\$7,051	\$7,300
Quartz with Undermount Sinks	WEL-V-60-D-QUU-W	\$7,123	\$7,373
Vanity Cabinet Only	WEL-V-60-D-VCO-W	\$2,800	\$3,050

NOTE: For Crest Mineral Composite tops, depth is shallower (18 1/8"). See page 86 for detailed top sizes.

NOTE: For Crest Mineral Composite tops, depth is shallower (18 1/8"). See page 86 for detailed top sizes.

Wall-to-Wall

WALL-TO-WALL 24"-32" SINGLE BOWL

Wall Hung

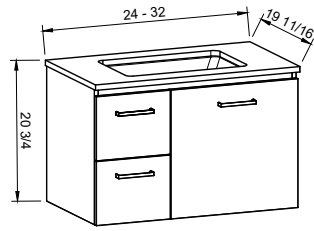

CABINET WITH	SKU	TIER 1 MSRP	TIER 2 MSRP
SilkSurface with Above Counter Sink	WTW-V-32-C-SSA-W	\$3,413	\$3,568
SilkSurface with Undermount Sink	WTW-V-32-C-SSU-W	\$3,448	\$3,602
Quartz with Above Counter Sink	WTW-V-32-C-QUA-W	\$4,138	\$4,219
Quartz with Undermount Sink	WTW-V-32-C-QUU-W	\$4,172	\$4,254
Vanity Cabinet Only	WTW-V-32-C-VCO-W	\$2,018	\$2,100

Floor Standing

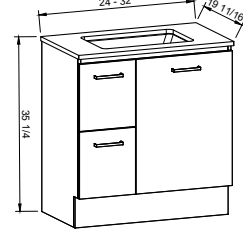

CABINET WITH	SKU	TIER 1 MSRP	TIER 2 MSRP
SilkSurface with Above Counter Sink	WTW-V-32-C-SSA-F	\$3,813	\$4,024
SilkSurface with Undermount Sink	WTW-V-32-C-SSU-F	\$3,847	\$4,059
Quartz with Above Counter Sink	WTW-V-32-C-QUA-F	\$4,537	\$4,676
Quartz with Undermount Sink	WTW-V-32-C-QUU-F	\$4,571	\$4,710
Vanity Cabinet Only	WTW-V-32-C-VCO-F	\$2,417	\$2,556

WALL-TO-WALL 33"-36" SINGLE BOWL

Wall Hung

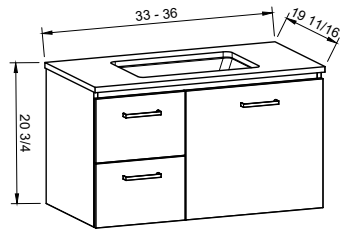

CABINET WITH	SKU	TIER 1 MSRP	TIER 2 MSRP
SilkSurface with Above Counter Sink	WTW-V-36-C-SSA-W	\$3,591	\$3,751
SilkSurface with Undermount Sink	WTW-V-36-C-SSU-W	\$3,626	\$3,785
Quartz with Above Counter Sink	WTW-V-36-C-QUA-W	\$4,321	\$4,407
Quartz with Undermount Sink	WTW-V-36-C-QUU-W	\$4,355	\$4,441
Vanity Cabinet Only	WTW-V-36-C-VCO-W	\$2,065	\$2,152

Floor Standing

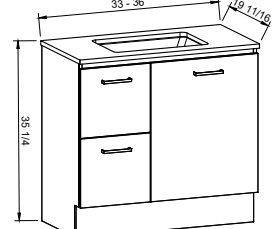

CABINET WITH	SKU	TIER 1 MSRP	TIER 2 MSRP
SilkSurface with Above Counter Sink	WTW-V-36-C-SSA-F	\$4,011	\$4,232
SilkSurface with Undermount Sink	WTW-V-36-C-SSU-F	\$4,046	\$4,266
Quartz with Above Counter Sink	WTW-V-36-C-QUA-F	\$4,740	\$4,888
Quartz with Undermount Sink	WTW-V-36-C-QUU-F	\$4,775	\$4,923
Vanity Cabinet Only	WTW-V-36-C-VCO-F	\$2,485	\$2,633

WALL-TO-WALL 37"-48" SINGLE BOWL

Wall Hung

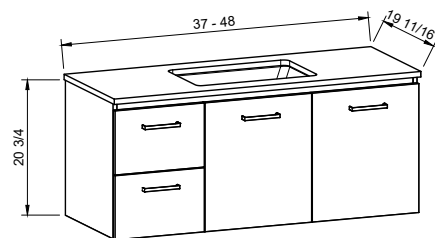

CABINET WITH	SKU	TIER 1 MSRP	TIER 2 MSRP
SilkSurface with Above Counter Sink	WTW-V-48-C-SSA-W	\$4,353	\$4,550
SilkSurface with Undermount Sink	WTW-V-48-C-SSU-W	\$4,387	\$4,584
Quartz with Above Counter Sink	WTW-V-48-C-QUA-W	\$5,349	\$5,452
Quartz with Undermount Sink	WTW-V-48-C-QUU-W	\$5,383	\$5,486
Vanity Cabinet Only	WTW-V-48-C-VCO-W	\$2,656	\$2,759

Floor Standing

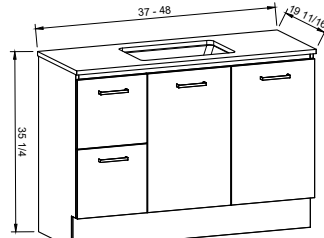

CABINET WITH	SKU	TIER 1 MSRP	TIER 2 MSRP
SilkSurface with Above Counter Sink	WTW-V-48-C-SSA-F	\$4,851	\$5,119
SilkSurface with Undermount Sink	WTW-V-48-C-SSU-F	\$4,885	\$5,153
Quartz with Above Counter Sink	WTW-V-48-C-QUA-F	\$5,847	\$6,021
Quartz with Undermount Sink	WTW-V-48-C-QUU-F	\$5,882	\$6,056
Vanity Cabinet Only	WTW-V-48-C-VCO-F	\$3,155	\$3,329

NOTE: Wall-to-Wall are custom orders and may take longer than standard product to manufacture. Exact sizes based on your width will be provided for your approval before production.

Wall-to-Wall

WALL-TO-WALL 60" DOUBLE BOWL

Wall Hung

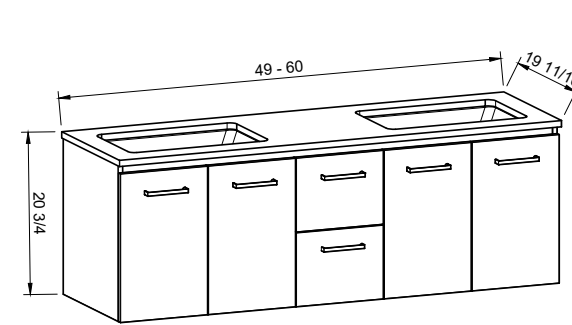

CABINET WITH	SKU	TIER 1 MSRP	TIER 2 MSRP
SilkSurface with Above Counter Sink	WTW-V-60-D-SSA-W	\$5,794	\$6,018
SilkSurface with Undermount Sink	WTW-V-60-D-SSU-W	\$5,863	\$6,087
Quartz with Above Counter Sinks	WTW-V-60-D-QUA-W	\$7,407	\$7,521
Quartz with Undermount Sinks	WTW-V-60-D-QUU-W	\$7,476	\$7,590
Vanity Cabinet Only	WTW-V-60-D-VCO-W	\$3,359	\$3,473

Floor Standing

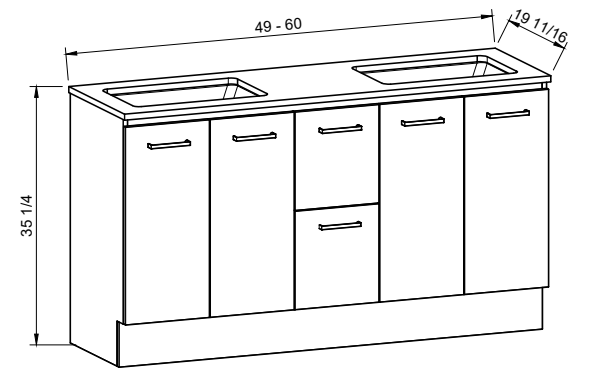

CABINET WITH	SKU	TIER 1 MSRP	TIER 2 MSRP
SilkSurface with Above Counter Sink	WTW-V-60-D-SSA-F	\$6,502	\$6,799
SilkSurface with Undermount Sink	WTW-V-60-D-SSU-F	\$6,571	\$6,867
Quartz with Above Counter Sinks	WTW-V-60-D-QUA-F	\$8,115	\$8,301
Quartz with Undermount Sinks	WTW-V-60-D-QUU-F	\$8,184	\$8,370
Vanity Cabinet Only	WTW-V-60-D-VCO-F	\$4,067	\$4,253

Mirrored Cabinets

ISLA

800mm / 32"

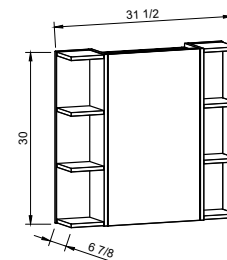

SKU	TIER 1 MSRP	TIER 2 MSRP
ISL-MC-32-W	\$1,706	\$1,924

900mm / 36"

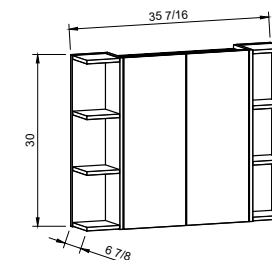

SKU	TIER 1 MSRP	TIER 2 MSRP
ISL-MC-36-W	\$1,801	\$2,029

1200mm / 48"

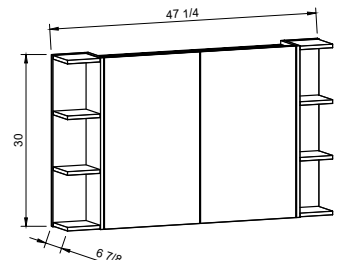

SKU	TIER 1 MSRP	TIER 2 MSRP
ISL-MC-48-W	\$2,231	\$2,490

1500mm / 60"

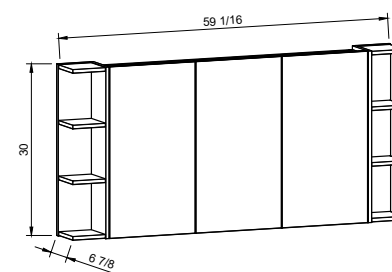

SKU	TIER 1 MSRP	TIER 2 MSRP
ISL-MC-60-W	\$2,470	\$2,759

JUNIPER

600mm / 24"

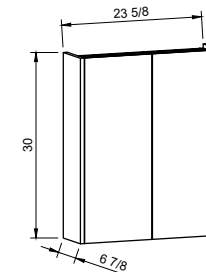

SKU	TIER 1 MSRP	TIER 2 MSRP
JUN-MC-24-W	\$1,572	\$1,753

800mm / 32"

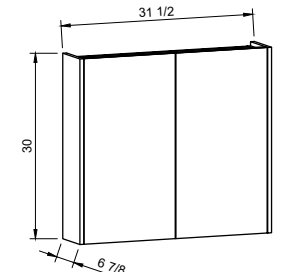

SKU	TIER 1 MSRP	TIER 2 MSRP
JUN-MC-32-W	\$1,704	\$1,905

Mirrored Cabinets

JUNIPER CONTINUED

900mm / 36"

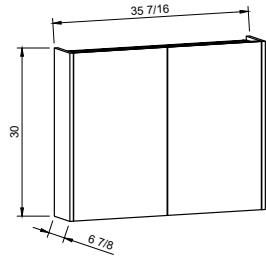

SKU	TIER 1 MSRP	TIER 2 MSRP
JUN-MC-36-W	\$1,774	\$1,984

1200mm / 48"

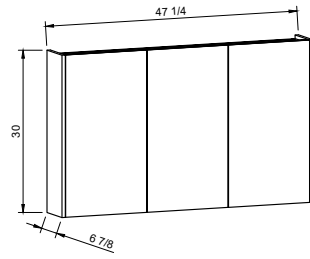

SKU	TIER 1 MSRP	TIER 2 MSRP
JUN-MC-48-W	\$2,246	\$2,487

1500mm / 60"

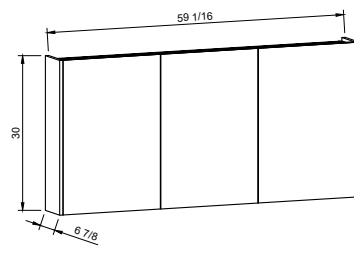

SKU	TIER 1 MSRP	TIER 2 MSRP
JUN-MC-60-W	\$2,452	\$2,723

RIDGE

400mm / 16"

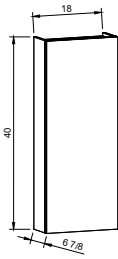

SKU	TIER 1 MSRP	TIER 2 MSRP
RID-MC-16-W	\$1,555	\$1,732

600mm / 24"

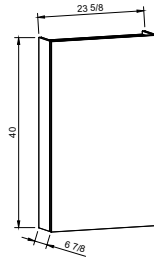

SKU	TIER 1 MSRP	TIER 2 MSRP
RID-MC-24-W	\$1,729	\$1,930

SAGE

600mm / 24"

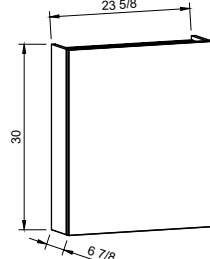

SKU	TIER 1 MSRP	TIER 2 MSRP
SAG-MC-24-W	\$1,556	\$1,736

800mm / 32"

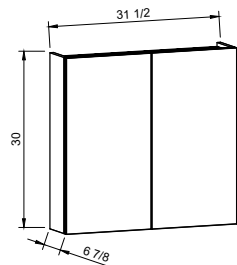

SKU	TIER 1 MSRP	TIER 2 MSRP
SAG-MC-32-W	\$1,700	\$1,897

900mm / 36"

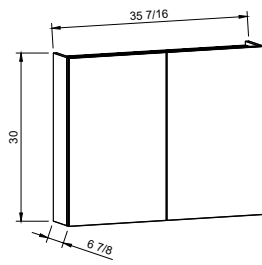

SKU	TIER 1 MSRP	TIER 2 MSRP
SAG-MC-36-W	\$1,771	\$1,979

1200mm / 48"

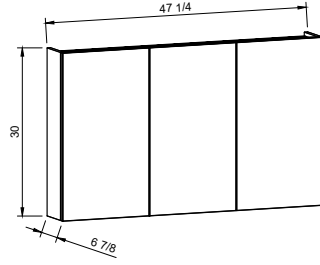

SKU	TIER 1 MSRP	TIER 2 MSRP
SAG-MC-48-W	\$2,252	\$2,490

WILLOW

1500mm / 60"

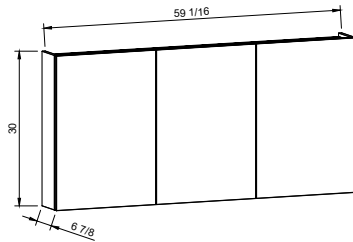

SKU	TIER 1 MSRP	TIER 2 MSRP
SAG-MC-60-W	\$2,464	\$2,732

600mm / 24"

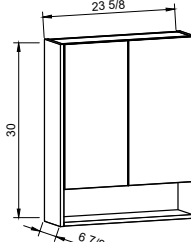

SKU	TIER 1 MSRP	TIER 2 MSRP
WIL-MC-24-W	\$1,592	\$1,789

800mm / 32"

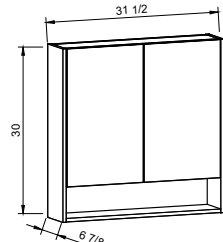

SKU	TIER 1 MSRP	TIER 2 MSRP
WIL-MC-32-W	\$1,721	\$1,936

Mirrored Cabinets

900mm / 36"

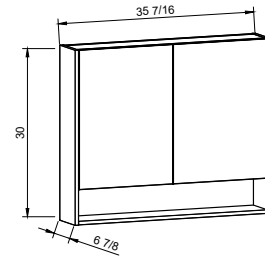

SKU	TIER 1 MSRP	TIER 2 MSRP
WIL-MC-36-W	\$1,791	\$2,016

1200mm / 48"

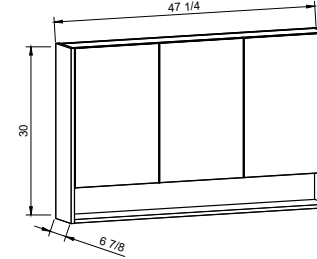

SKU	TIER 1 MSRP	TIER 2 MSRP
WIL-MC-48-W	\$2,264	\$2,520

1500mm / 60"

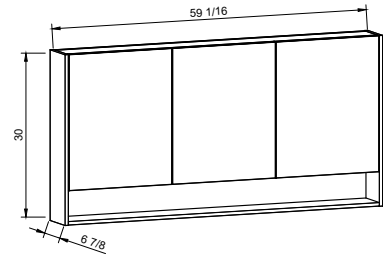

SKU	TIER 1 MSRP	TIER 2 MSRP
WIL-MC-60-W	\$2,469	\$2,756

Floating Shelves

FLOATING SHELVES

450mm / 18"

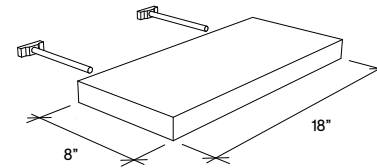

SKU	TIER 1 MSRP	TIER 2 MSRP
FSH-S-18-W	\$273	\$285

525mm / 21"

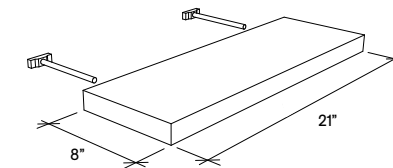

SKU	TIER 1 MSRP	TIER 2 MSRP
FSH-S-21-W	\$283	\$306

600mm / 24"

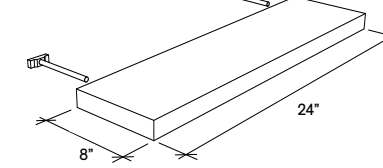

SKU	TIER 1 MSRP	TIER 2 MSRP
FSH-S-24-W	\$290	\$317

Linen Closets

BRIAR

450mm / 18" Wall Hung

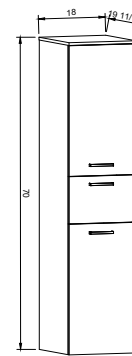

SKU	TIER 1 MSRP	TIER 2 MSRP
BRI-LC-18-W	\$2,741	\$3,109

450mm / 18" Floor Standing

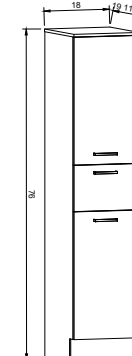

SKU	TIER 1 MSRP	TIER 2 MSRP
BRI-LC-18-F	\$2,842	\$3,231

450mm / 18" On Legs

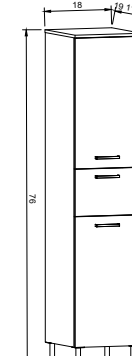

SKU	TIER 1 MSRP	TIER 2 MSRP
BRI-LC-18-L	\$2,842	\$3,231

Linen Closets

BRIAR CONTINUED

525mm / 21" Wall Hung

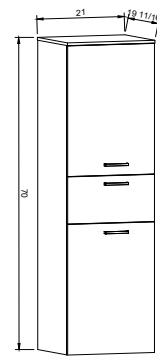

SKU	TIER 1 MSRP	TIER 2 MSRP
BRI-LC-21-W	\$2,852	\$3,239

525mm / 21" Floor Standing

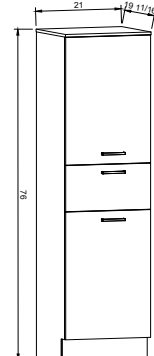

SKU	TIER 1 MSRP	TIER 2 MSRP
BRI-LC-21-F	\$2,959	\$3,368

525mm / 21" On Legs

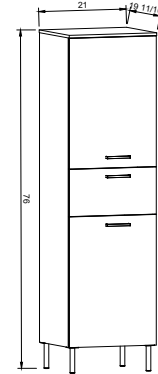

SKU	TIER 1 MSRP	TIER 2 MSRP
BRI-LC-21-L	\$2,959	\$3,368

600mm / 24" Wall Hung

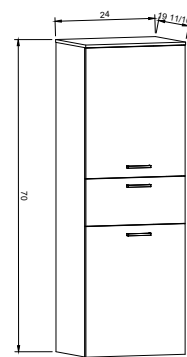

SKU	TIER 1 MSRP	TIER 2 MSRP
BRI-LC-24-W	\$2,962	\$3,368

600mm / 24" Floor Standing

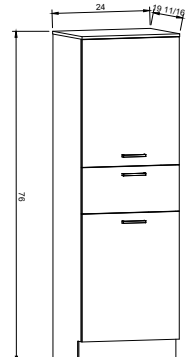

SKU	TIER 1 MSRP	TIER 2 MSRP
BRI-LC-24-F	\$3,076	\$3,503

600mm / 24" On Legs

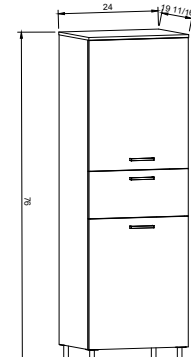

SKU	TIER 1 MSRP	TIER 2 MSRP
BRI-LC-24-L	\$3,076	\$3,503

DUNE

450mm / 18" Wall Hung

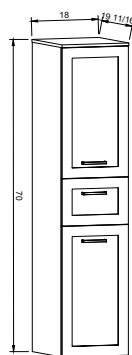

SKU	TIER 2 MSRP
DUN-LC-18-W	\$3,432

450mm / 18" Floor Standing

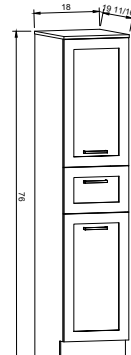

SKU	TIER 2 MSRP
DUN-LC-18-F	\$3,535

450mm / 18" On Legs

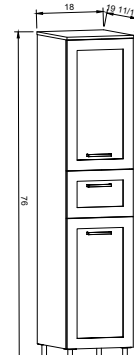

SKU	TIER 2 MSRP
DUN-LC-18-L	\$3,535

Linen Closets

DUNE CONTINUED

525mm / 21" Wall Hung

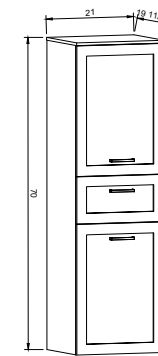

SKU	TIER 2 MSRP
DUN-LC-21-W	\$3,615

525mm / 21" Floor Standing

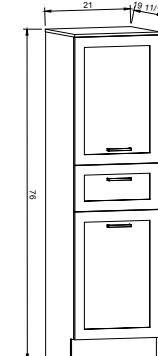

SKU	TIER 2 MSRP
DUN-LC-21-F	\$3,723

525mm / 21" On Legs

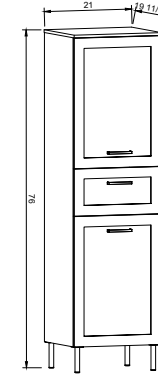

SKU	TIER 2 MSRP
DUN-LC-21-L	\$3,723

600mm / 24" Wall Hung

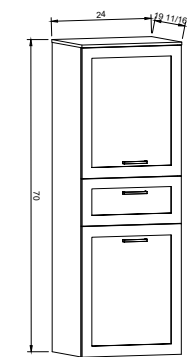

SKU	TIER 2 MSRP
DUN-LC-24-W	\$3,796

600mm / 24" Floor Standing

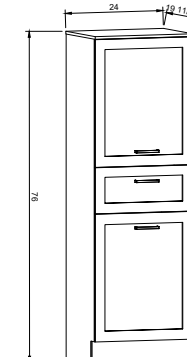

SKU	TIER 2 MSRP
DUN-LC-24-F	\$3,911

600mm / 24" On Legs

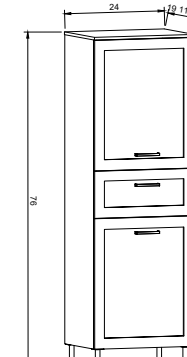

SKU	TIER 2 MSRP
DUN-LC-24-L	\$3,911

TERRA

450mm / 18" Wall Hung

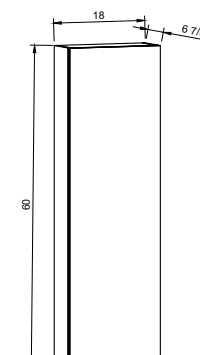

SKU	TIER 1 MSRP	TIER 2 MSRP
TER-LC-18-W	\$1,906	\$2,126

525mm / 21" Wall Hung

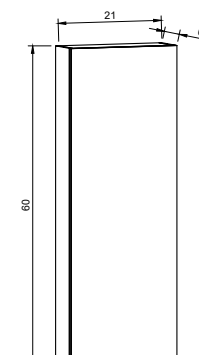

SKU	TIER 1 MSRP	TIER 2 MSRP
TER-LC-21-W	\$1,994	\$2,227

600mm / 24" Wall Hung

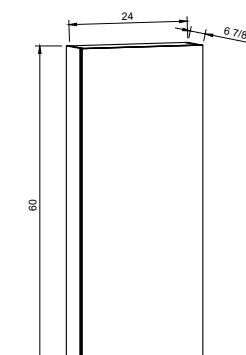

SKU	TIER 1 MSRP	TIER 2 MSRP
TER-LC-24-W	\$2,085	\$2,295

Linen Closets

VALE

300mm / 12" Wall Hung

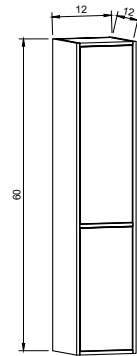

SKU	TIER 1 MSRP	TIER 2 MSRP
VAL-LC-12-W	\$2,316	\$2,665

WREN

300mm / 12" Wall Hung

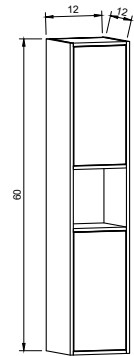

SKU	TIER 1 MSRP	TIER 2 MSRP
WRE-LC-12-W	\$2,316	\$2,665



Already picked a color palette for your bathroom?

Custom order your vanity in any **Benjamin Moore** or **Sherwin Williams** paint color!

Use SKU **ANY-PAIN-T-COLOR** to order in a custom paint color. Available anywhere paint is available. See pg 80.

Shown in **Benjamin Moore Blue Nova**, Color of the year 2024.



Want a Full Depth Vanity?

Upgrade to a 22 1/2" Deep Vanity with a SilkSurface or Quartz Top

See page 79 for pricing and information.

Cabinet Customization and Upgrades

Love a vanity but wish it was just a bit taller? Or had one more drawer? Use our easy customizing option pricelist to easily make your vanity exactly as you want it. Use the Custom Vanity Order Form on the resources page of our website to let us know how to customize your vanity.



CABINET SIZE CUSTOMIZATION AND UPGRADES

Cabinet Size Upgrade Customizing Options		
	SKU	MSRP
Add extra drawer (per drawer)	CUST-DRAW-ADD	\$199
Delete drawers and have doors only	DOORS-ONLY	No Cost
Change grain direction to vertical (excluding toe kicks over 4")	VER-GRAIN	\$74
Increase vanity cabinet height or depth (Max 6") (Does not apply to top)	CUST-INCREASE-CAB	\$142
Upgrade toe kick to seamless toe kick across multiple vanities and/or linen closets (up to 8')	CUST-TOEKICK	\$99



ADD DRAWERS (EA) | CUST-DRAW-ADD | \$199



REMOVE DRAWERS | DOORS-ONLY | \$0



SEAMLESS TOEKICK | CUST-TOEKICK | \$99

FULL DEPTH CABINET UPGRADES

Full Depth Upgrade Customizing Options		
	SKU	MSRP
Increase vanity to full depth (Cabinet Only) 21" Cabinet Box to suit 22 1/2" Countertop	FULL-DEPTH-CAB	\$142
Increase vanity to full depth (Includes SilkSurface Top) 21" Cabinet Box , 22 1/2" Countertop	FULL-DEPTH-CAB-SS	\$409
Increase vanity to full depth (Includes Quartz Top) 21" Cabinet Box , 22 1/2" Countertop	FULL-DEPTH-CAB-QU	\$588



INCREASE VANITY TO FULL DEPTH WITH SILKSURFACE TOP (21" Cabinet Box , 22 1/2" Countertop) | FULL-DEPTH-CAB-SS | \$409

Cabinet Customization and Upgrades

COLOR UPGRADES

Color Upgrade Customizing Options		
	SKU	MSRP
Custom finish your cabinet in any Sherwin Williams or Benjamin Moore paint color	ANY-PAINT-COLOR	\$500
Upgrade the interior of your cabinet to match the exterior. Drawers will remain white.	MATCH-INTERIOR	\$440



CUSTOM BENJAMIN MOORE OR SHERWIN WILLIAMS COLOR | ANY-PAINT-COLOR | \$500 (SHOWN IN BM TOPAZ)

UPGRADE INTERIOR TO MATCH EXTERIOR | MATCH-INTERIOR | \$220

COUNTERTOP SIZE CUSTOMIZATION AND UPGRADES

Countertop Upgrade Customizing Options		
	SKU	MSRP
Increase SilkSurface top width or depth (Max 6")	CUST-INCREASE-SS	\$267
Increase Quartz top width or depth (Max 6")	CUST-INCREASE-QU	\$446
Add 4" high Backsplash in SilkSurface	BACKSPLASH-SS	\$292
Add 4" high Sidesplash in SilkSurface	SIDESPLASH-SS	\$210
Add 4" high Backsplash in Quartz	BACKSPLASH-QU	\$483
Add 4" high Sidesplash in Quartz	SIDESPLASH-QU	\$421



ADD 4" HIGH BACKSPLASH | BACKSPLASH-QU | \$483

CABINET OUTLETS

Leave your shaver charging or your hair dryer permanently plugged in for easy use. For multi-drawer cabinets just let us know which drawer you would like your in-drawer outlet in.

Please note that a wall outlet to plug the in-drawer outlet into will be required behind the vanity. Standard position for in-drawer power points is top left drawer unless specified otherwise.



Cabinet Outlets		
	SKU	MSRP (EA)
In-Drawer Outlet	PPT-OPT-INDRW	\$355
Mirrored Cabinet Outlet	PPT-OPT-MMC	\$355

UNDERCABINET LIGHTING

These beautiful lighting kits can be ordered as optional extras on any vanity, mirrored cabinet or linen closet. They come fully installed. All you need to do is have your electrician provide a connection and your chosen switching.

It mounts underneath the cabinet or if your cabinet is floor standing, it mounts just above the toekick. **Requires switched outlet.**



Cabinet Lighting		
	SKU	MSRP (EA)
LED Under Cabinet lighting kit complete with plugin transformer	LIGHT-KIT	\$355

FILLERS AND PANELS

Need to mount your vanity against a wall? Order a filler panel for next to your vanity, mirrored cabinet or linen closet for easy install. The filler panel, which is 3" x cabinet height, and 5/8" thick, can be cut to size onsite for exact measurements. If ordered with a top, we will account for the filler width.



Fillers and Panels		
	SKU	MSRP (EA)
Filler - Left or Right Vanity Filler Panel (4" wide x Vanity Height x 5/8" thick)	FIL-PAN	\$76
Filler - Left or Right Linen Closet Filler Panel (4" wide x Cabinet Height x 5/8" thick)	FIL-PAN-TALL	\$94



Wells Vanity 36" WEL-V-36-C-SSU-W-WH-CRG-CB-1 | \$3,817. Willow Mirrored Cabinet WIL-MC-36-W-WH | \$2,016.

Cabinet Options

- 84 About Our Vanity Tops
- 86 Vanity Tops
- 87 Sink Collection
- 88 Cabinet Hardware
- 90 Cabinet Legs
- 91 Quartz Countertop Colors
- 92 SilkSurface Countertop Colors
- 94 Woodgrain Laminate Colors
- 96 Wood Veneer Colors
- 98 Painted Colors
- 101 Order Form/Checklist
- 102 Installation & Warranty



About Our Vanity Tops

What really is the difference between our various vanity top options? Which is better? See the pros and cons below.



Mineral Composite Vanity Tops

Mineral composite tops are heat formed to an exact mould and back filled with a heavy compound.

- ✓ Very straight and flat
- ✓ Durable and strong
- ✓ Cost effective
- ✓ Not susceptible to chipping
- ✓ 10 year warranty
- ✗ Susceptible to heat damage (e.g. Hair straightener)



Quartz Tops

Quartz tops ensure a strong, compact slab. Stain resistant, maintenance free, durable & food safe.

- ✓ Strong & durable material
- ✓ Stain resistant
- ✓ Full lifetime warranty
- ✓ Premium Quality
- ✓ Can order custom sizes
- ✗ Susceptible to chipping
- ✗ Surface variations to be expected due to quartz being made from natural materials



Laminate Tops

A stylish top that is available on the Finn and as a box top on the Tuscany, this sleek top completes the sophisticated look.

- ✓ Stylish and unique
- ✓ Durable laminate
- ✓ 5 year warranty
- ✓ Can order custom sizes
- ✗ Susceptible to heat damage (e.g. Hair straightener)
- ✗ Susceptible to chipping due to impact



SilkSurface Tops

SilkSurface is a 2cm solid surface material. These solid surfaces have a beautiful blend of colors with a realistic stone appearance

- ✓ Non-porous, good stain resistance
- ✓ Very easy to repair if scratched
- ✓ Crack and chip resistant
- ✓ Can be drilled onsite easily
- ✓ 10 year warranty
- ✓ Can order custom sizes
- ✗ Susceptible to scratching

About Mineral Composite

Mineral Composite is a material that fully utilizes the extraordinary properties of dolomite. The combination of dolomite and elastic resin imparts unparalleled durability and impact-resistance to Mineral Composite. The external surface is covered with gel-coat. This type of coating is also applied to the surface of yacht hulls and wind turbine blades – places exposed to constant contact with the elements: wind and water.

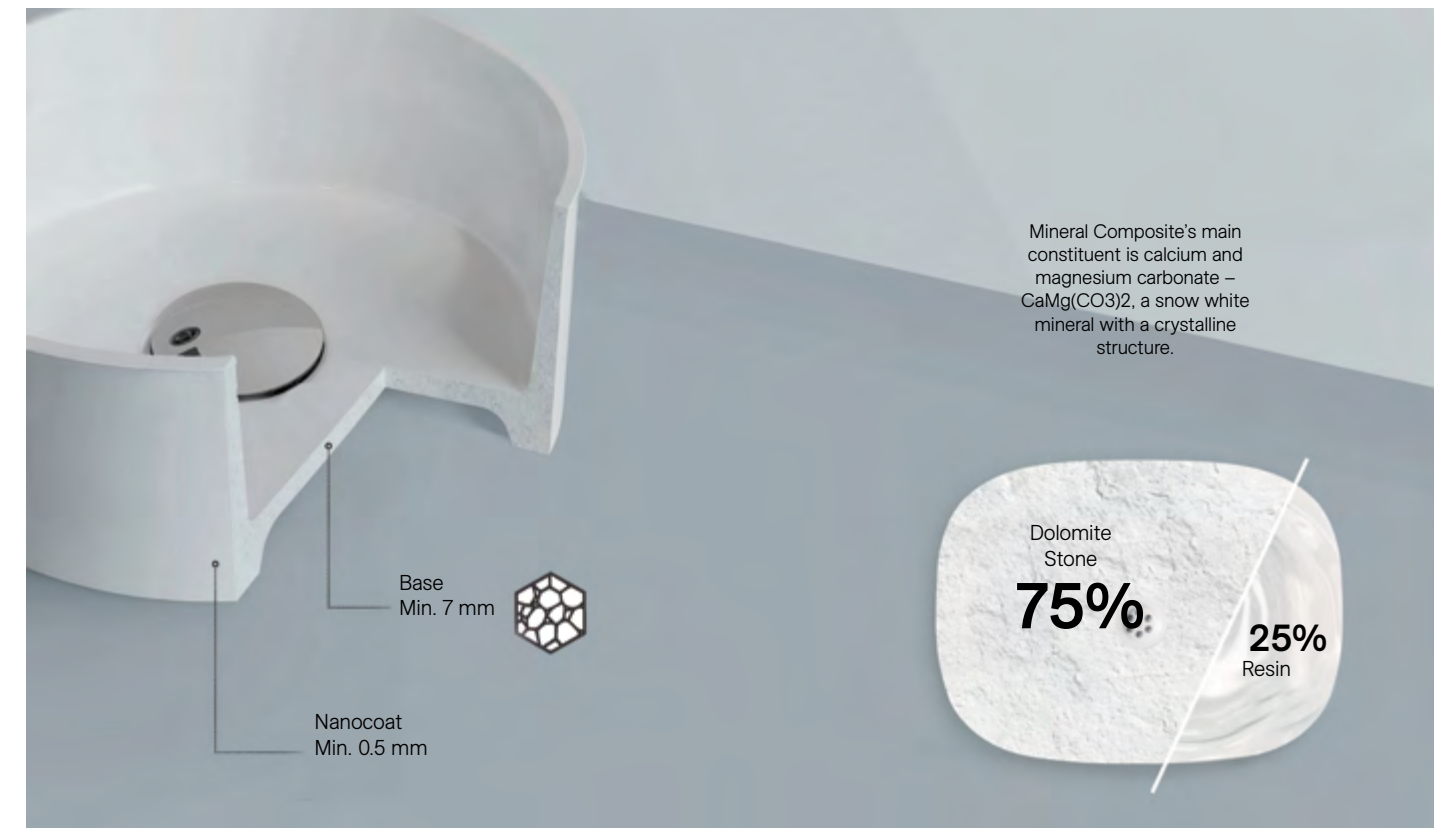

Vanity Tops

Prices are for purchasing tops independently. Integrated one-piece tops, such as the Peak and Crest tops do not need an additional sink. If you are purchasing a Quartz or SilkSurface top only, sink/s are not included and will be need to be ordered as well.



Peak Gloss Mineral Composite Top
(With overflow to back. Chrome or White overflow outlet only.)



Crest Gloss Mineral Composite Top
(With overflow to back. Chrome or White overflow outlet only.)

Normal Depth - 19 11/16"

Sizes		Peak (Mineral Composite)		Quartz for Vessel Sink		Quartz for Undermount	
TOP SIZE (mm)	TOP SIZE (INCHES)	SKU	MSRP	SKU	MSRP	SKU	MSRP
600 x 500	23 5/8" x 19 11/16"	PEA-TP-24-C	\$338	QUA-TP-24-C	\$1,969	QUU-TP-24-C	\$1,969
800 x 500	31 1/2" x 19 11/16"	PEA-TP-32-C	\$394	QUA-TP-32-C	\$2,284	QUU-TP-32-C	\$2,284
900 x 500	35 7/16" x 19 11/16"	PEA-TP-36-C	\$468	QUA-TP-36-C	\$2,427	QUU-TP-36-C	\$2,427
1200 x 500	47 1/4" x 19 11/16"	PEA-TP-48-C	\$559	QUA-TP-48-C	\$2,886	QUU-TP-48-C	\$2,886
1500 x 500 Double	59 1/16" x 19 11/16"	PEA-TP-60-D	\$767	QUA-TP-60-D	\$4,367	QUU-TP-60-D	\$4,367

Normal Depth - 19 11/16"

Sizes		SilkSurface for Vessel Sink		SilkSurface for Undermount	
TOP SIZE (mm)	TOP SIZE (INCHES)	SKU	MSRP	SKU	MSRP
600 x 500	23 5/8" x 19 11/16"	SSA-TP-24-C	\$1,247	SSU-TP-24-C	\$1,247
800 x 500	31 1/2" x 19 11/16"	SSA-TP-32-C	\$1,523	SSU-TP-32-C	\$1,523
900 x 500	35 7/16" x 19 11/16"	SSA-TP-36-C	\$1,661	SSU-TP-36-C	\$1,661
1200 x 500	47 1/4" x 19 11/16"	SSA-TP-48-C	\$2,075	SSU-TP-48-C	\$2,075
1500 x 500 Double	59 1/16" x 19 11/16"	SSA-TP-60-D	\$2,909	SSU-TP-60-D	\$2,909

Shallow Depth - 18 1/8"

Sizes		Crest (Mineral Composite)	
TOP SIZE (mm)	TOP SIZE (INCHES)	SKU	MSRP
610 x 460	24 1/8" x 18 1/8"	CRE-TP-24-C	\$338
810 x 460	31 7/8" x 18 1/8"	CRE-TP-32-C	\$394
910 x 460	35 13/16" x 18 1/8"	CRE-TP-36-C	\$468
1200 x 460	47 1/4" x 18 1/8"	CRE-TP-48-C	\$559
1500 x 460 Double	59 1/16" x 18 1/8"	CRE-TP-60-D	\$767

Sink Collection

Prices are for purchasing sinks independently. Vanities with above counter vessel or undermount sinks include the sink in their price.

Round White

Mineral Composite
BAS-17-ROU | \$362

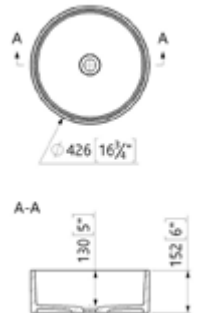

Square White

Mineral Composite
BAS-18-SQU | \$362

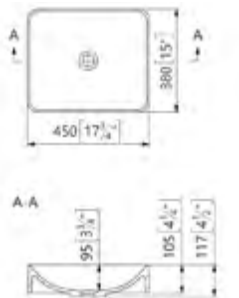
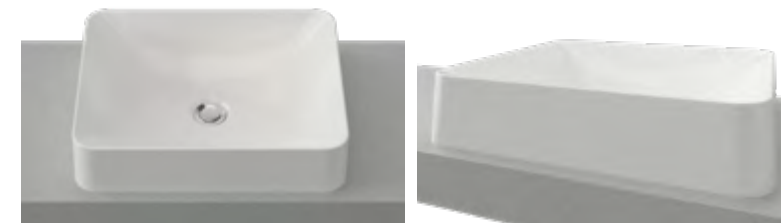

Rectangle White

Mineral Composite
BAS-20-REC | \$362

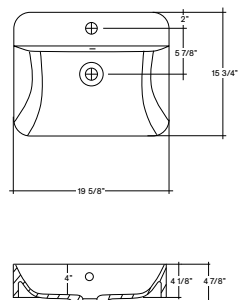

Undermount Sink

Ceramic
BAS-21-UND | \$362

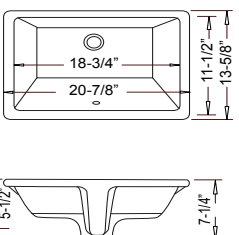

NOTE: Wastes not included for any sinks. Rectangle sink shown with faucet. Faucet is not provided but faucet landing is (Rectangle sink only).

Cabinet Hardware

What a selection! Choose from nickel, black or gold - long or short - square or curved. We've got them all! Customize your cabinet with any of these stunning handle options at no extra cost! **Hardware comes factory installed unless noted.**

Bar Pull

Available in 3", 6" & 10"

SKU Code:

-BP

-Size: 3, 6, or 10

-Finish: N, B, or G

eg. -BP3N-



Nickel



Black



Gold

Square

Available in 5", 7 1/2" & 10"

SKU Code:

-SQ

-Size: 5, 7, or 10

-Finish: N, B, or G

eg. -SQ5N-



Nickel



Black



Gold

Industrial Pull

Available in 6" & 10"

SKU Code:

-IN

-Size: 6, or 10

-Finish: N, or B

eg. -IN6N-



Nickel



Black

Ova Top

Available in 4", 7 3/4" & 13 3/4"

SKU Code:

-OV

-Size: 4, 7, or 13

-Finish: N, B, or G

eg. -OV4N-



Nickel



Black



Gold

Round Knob

Available in 1 1/4"

SKU Code:

-KN

-Finish: N, B, or G

eg. -KNN-



Nickel



Black



Gold

Retro Cup Pull

Available in 3"

SKU Code:

-RE

-Finish: N, B, or G

eg. -REN-



Nickel



Black



Gold

Crescent Pull

Available in 3 3/4"

SKU Code:

-CR

-Finish: N, B, or G

eg. -CRN-

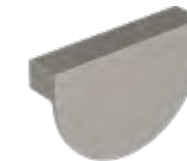

Nickel



Black



Gold

Push-to-Open

Available on all doors and drawers. No up-charge.

SKU Code:

-PTO-

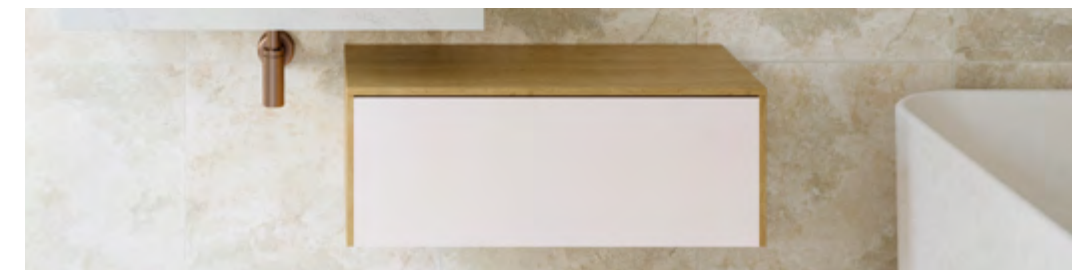

Cabinet Legs

If your chosen vanity or linen closet is mounted on legs, you can select from these options below.

Straight legs

Available in 5 3/4"

SKU Code:

-ST

-Finish: **N, B, or G**

eg. -STN-



Nickel

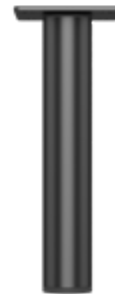

Black



Gold

Arrow legs

Available in 5 3/4"

SKU Code:

-AR

-Finish: **N, B, or G**

eg. -ARN-



Nickel



Black



Gold

Angled legs

Available in 7 3/4"

SKU Code:

-AG

-Finish: **N, B, or G**

eg. -AGN-



Nickel



Black



Gold

NOTE: Cabinet height may adjust to compensate for different leg heights, overall vanity height will remain 34 1/2". Legs are decorative (the cabinet must still be mounted to the wall). Legs are shipped loose and will need to be installed during vanity installation, exact placement is left to the choice of the customer.

Cambria Quartz Collection



Cambria is a 2cm thick quartz. Cambria is among the highest concentration of pure quartz to ensure strong, compact slabs. Stain resistant, maintenance free, durable & food safe.

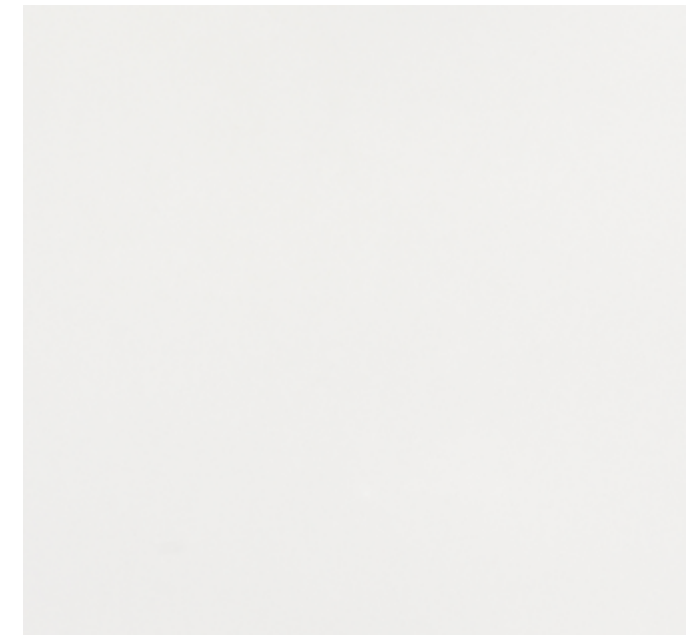

Whitehall™
-WL-



Torquay™
-TQ-



Colton™
-CN-

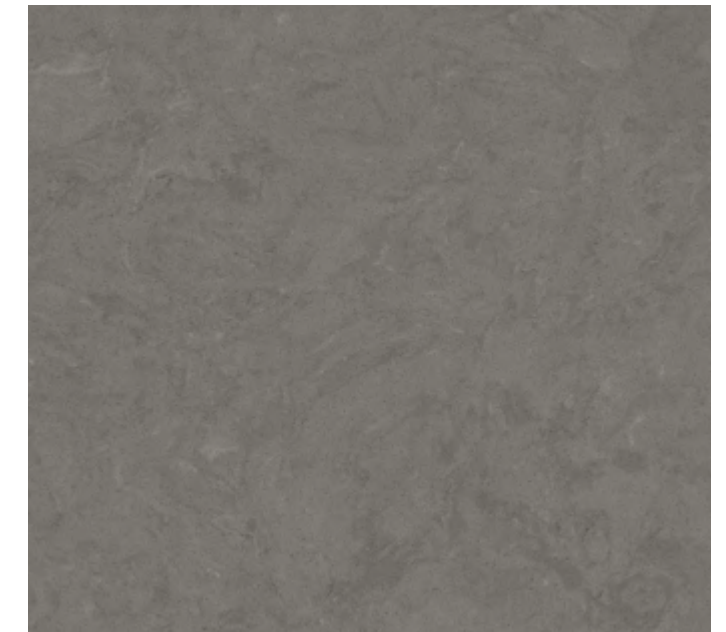

Carrick™
-CK-

Cambria may be substituted for equivalent colors if required. Cambria is made from natural quartz and therefore some variation on color and aggregate may occur. As each slab is individual, natural variation in graining and coloring is to be expected. While the colors in this brochure are to the highest standard in printing, it should only be used as an indication of actual product design. Please visit your local showroom to view larger samples.

SilkSurface Colors

SilkSurface™

SilkSurface is the right choice for enduring beauty. With a beautiful blend of colors and a realistic natural appearance, these high performance 2cm counter-tops are manufactured using a special multi-process technique making them resistant to stains, cracks and chips.

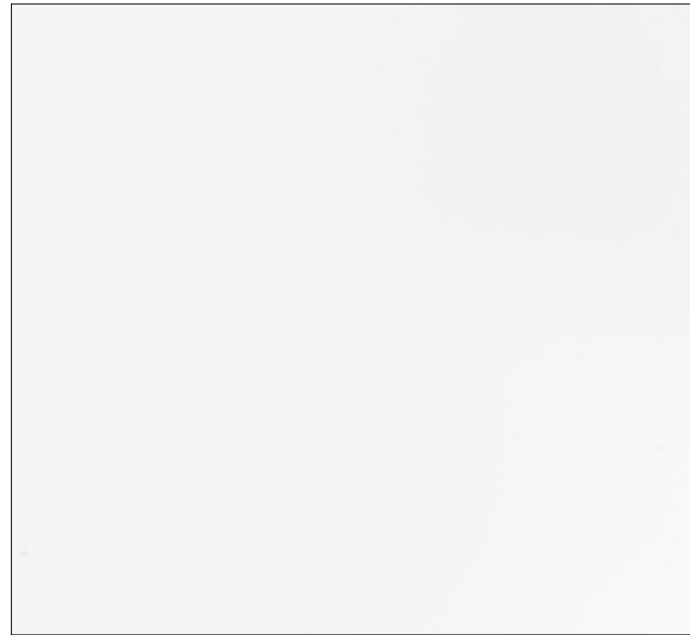

Arctic White
-AW-



Carrara
-CA-



Cobblonite
-CB-

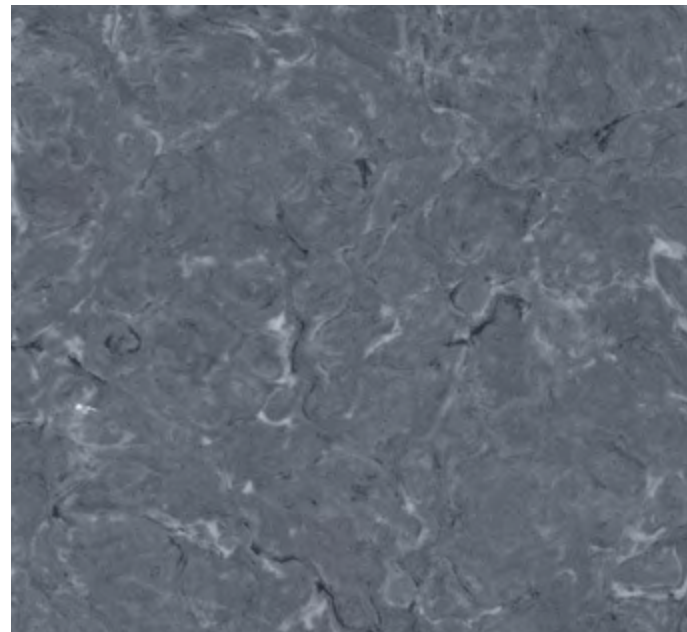

Moonstone
-MS-

SilkSurface is man-made slab with an acrylic resin base. As each slab is individual, natural variation in graining and coloring is to be expected. While the colors in this brochure are to the highest standard in printing, it should only be used as an indication of actual product design. Please visit your local showroom to view larger samples.



Kodiak Vanity 48" KOD-V-48-C-SSU-L-OS-CRN-CA0-ARN | \$5,912. Sage Mirrored Cabinet SAG-MC-48-W-OS | \$2,490.

Woodgrain Colors - Tier 1

Woodgrain finishes capture the color and texture of natural timbers such as oak, maple and walnut. Made from a highly durable Thermally fused laminate (TFL), They add warmth and color to your bathroom while being ultra durable, easy to clean, affordable, and a great sustainably sourced option. Choose any of these colors - at no extra cost!



Scan the QR code to order your free samples.



Weekend Getaway
-WG-



Sheer Beauty
-SB-

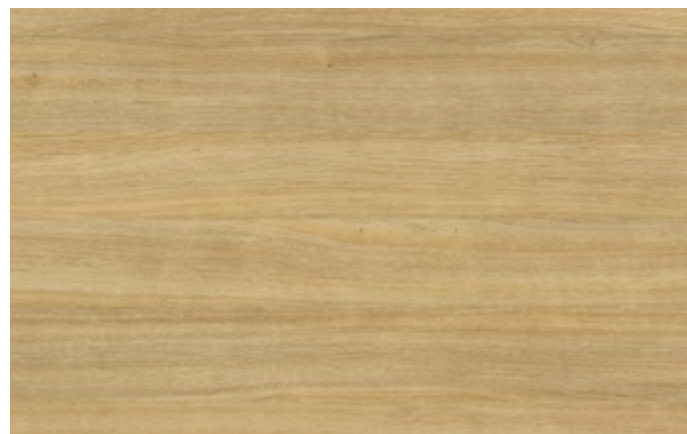

Rhapsody
-RH-

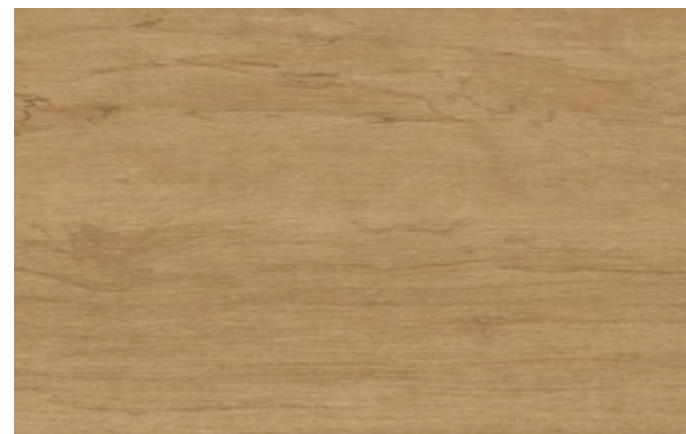

Sugar Rush
-SR-



New Wave
-NW-

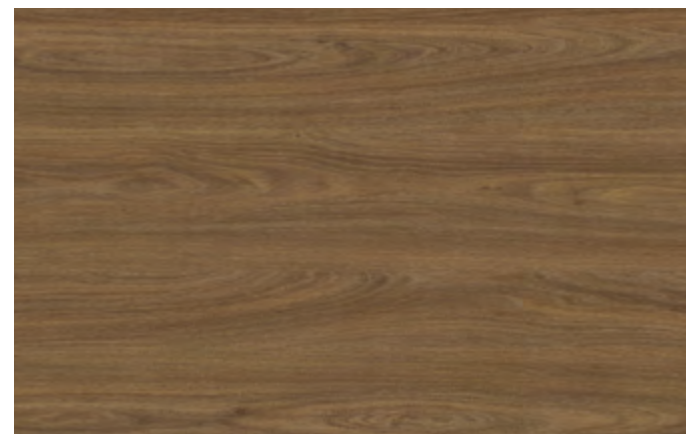

Kiss Curl
-KC-



Sunday Stroll
-SS-



Simply Gallant
-SG-



Tete a Tete
-TT-



Night Owl
-NO-

NOTE: Not available in shaker style cabinets including Kodiak and Dune. Due to manufacturing process grain patterns do not line up across panels. Horizontal grain is standard on vanity units. Grain direction may vary for Linen and Mirrored Cabinets. Some woodgrains have a matte finish while others have a realistic texture. While the colors in this brochure are to the highest standard in printing, it should only be used as an indication of actual product design. Please visit your local showroom to view larger samples.

Wood Veneer Colors - Tier 2

All of our wood veneer is an American Red Oak. Doors styles are either flat panel or shaker style (door style based on vanity range, flat panel style doors on all ranges except Kodiak vanity and Dune Linen Closet, which are shaker style).



Scan the QR code to order your free samples.



Natural
-NA-



Cornsilk
-CO-

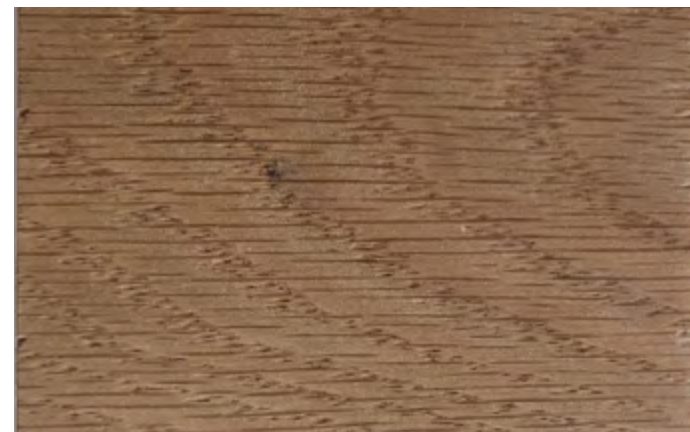

Ice Brown
-IB-



Ash Grey
-AG-

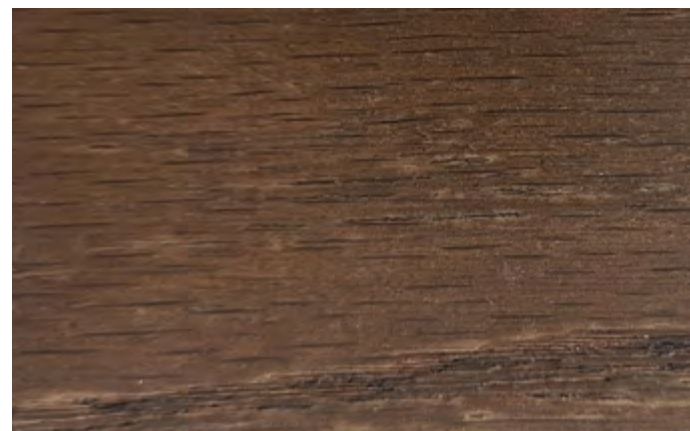

Chocolate
-CL-

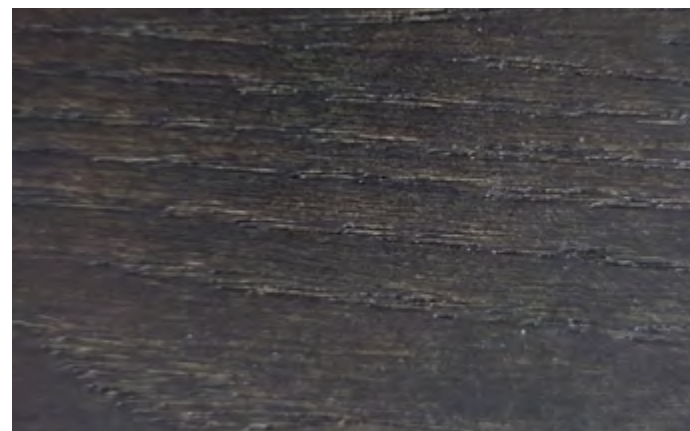

Charcoal
-CH-



NOTE: Due to the manufacturing process, grain patterns do not line up across panels. Horizontal grain is standard on flat panel doors. 5-Piece doors in the Kodiak and Dune range have a mix of grain directions. Grain direction may vary for linen closets and mirrored cabinets.

Painted Colors - Tier 2

We offer a range of standard paint colors in a satin finish. If you would like to order your painted vanity in a custom color, see page 80 for our custom color program.



Scan the QR code to order your free samples.

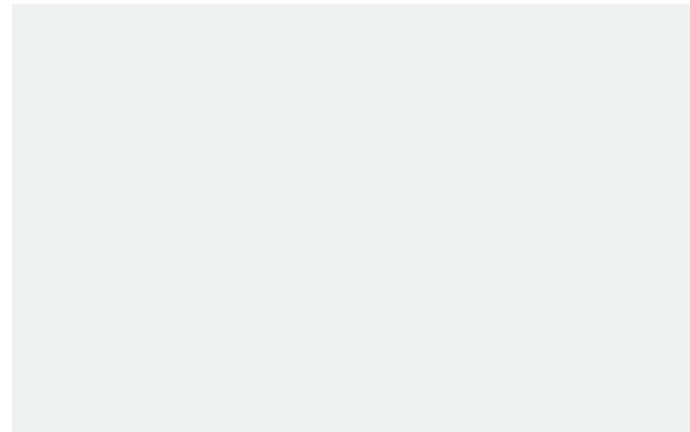

White Satin
-WH-

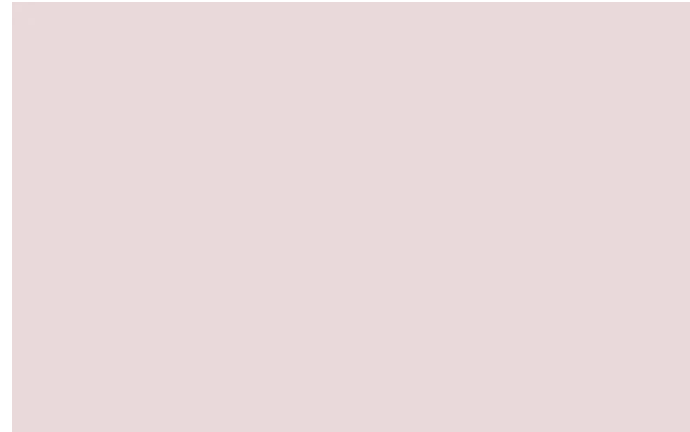

Pastel Pink Satin
-PP-



Navy Blue Satin
-NB-



Emerald Green Satin
-EG-

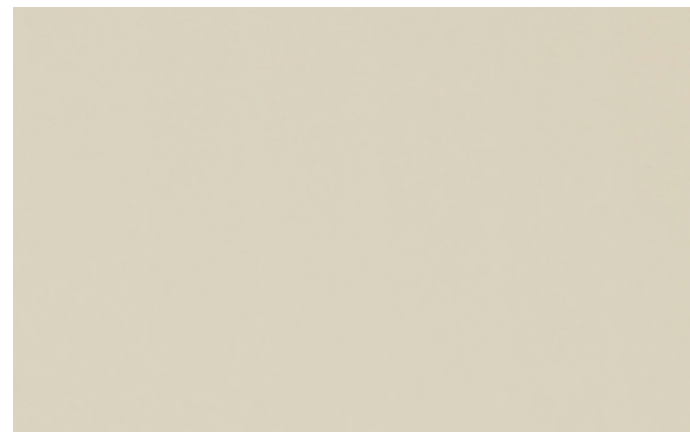

Grey Beige Satin
-GB-



Olive Satin
-OS-



Dark Grey Satin
-DG-

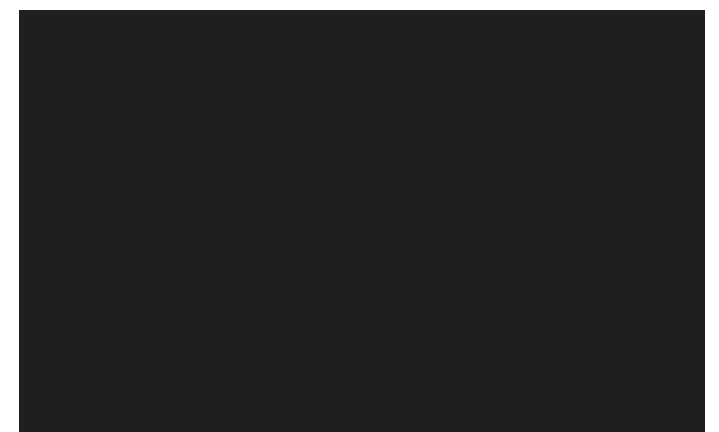

Black Satin
-BL-



Duck Egg Blue Satin
-DB-

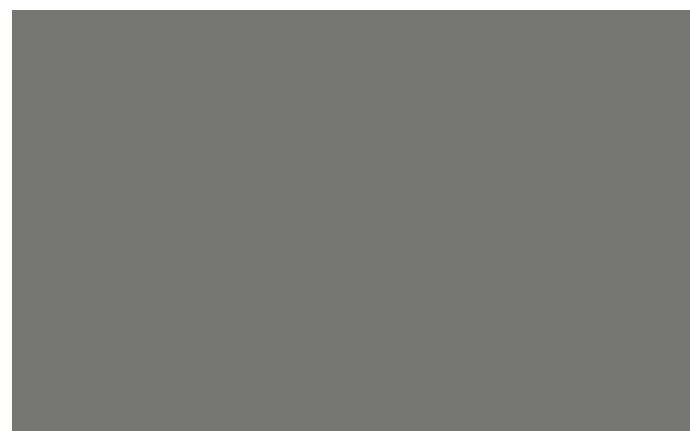

Light Grey Satin
-LG-

NOTE: Shaker style cabinets including Kodiak and Dune are only available in Painted Finishes or Wood Veneers.

Choose Your Vanity in Just 6 Steps

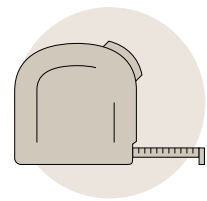

1. MEASURE YOUR SPACE

Do a simple sketch of your bathroom and add dimensions of walls, windows, doors, plumbing pipes, and electrical outlets to help visualize your space and how your new vanity will fit into it.

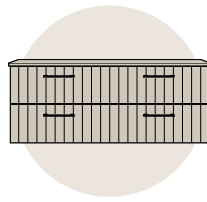

2. PICK A VANITY STYLE

Ask instore to get an idea of which vanity styles are right for you. Some vanities are better suited to large bathrooms, while others are tailor made for small spaces. Regardless of how big your bathroom is, Timberline has a huge range of wonderful options for you to choose from.

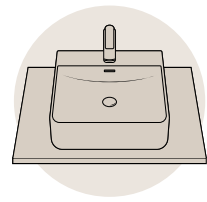

3. CHOOSE A TOP AND SINK

Your chosen vanity will open up a unique range of top and sink options. Check out the options on Page 78 to make sure you get just the look you are after.

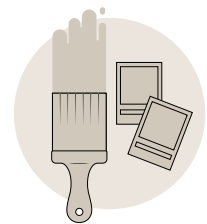

4. COLORS AND HANDLES

You're getting close now! It's time to finish the look by choosing the perfect colors and handles for your new vanity.

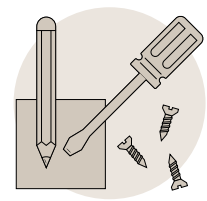

5. CUSTOMIZE

Looking for a little extra something to make it truly yours? From under cabinet lighting to drawer upgrades, or outlets to increased cabinet height, we will custom make your vanity, just for you.



6. ORDER IN-STORE

Congratulations! All that's left to do is order your new bathroom vanity today via an authorized dealer!



CABINET ORDER FORM/CHECKLIST

To make life easy, fill this form in with your customer. Please fill out each option to ensure all details are correct.

Email to: sales.usa@timberlinebp.com

STORE DETAILS

Company Name: Completed by:
 Purchase Order No: Date:

CUSTOMER DETAILS

Customer Name: Customer Contact No:
 Customer Signature:

RANGE		WIDTH	
Write Range Here:		Write Size Here:	
TOP STYLE		TOP COLOR (if applicable)	
Write Top Style Here:		Write Top Color Here:	
SINKS (if applicable)			
Write Range Name Here:			
SINK POSITION (if applicable)			
Center	Left-Hand Side	Right-Hand Side	Double
FAUCET HOLES			
No Faucet Holes	1 Faucet Hole (please select position below)		3 Faucet Holes
Faucet Hole Position:	Rear	Left-Hand	Right-Hand
For 3 Faucet Holes:	Centerset (4" O/C)		Widespread (8" O/C)
CABINET COLOR TIER		CABINET COLOR	
Tier 1	Tier 2	Write Cabinet Color Here:	
MOUNT			
Wall Hung	Floor Standing	Legs (Freestanding)	
LEGS (if applicable)			
Write Range Name Here:		Write Range Color Here:	
DRAWERS (if applicable)		LINEN/MIRRORED CABINET HINGE (if applicable)	
Left-hand	Right-hand	Left-hand Side	Right-hand Side
HANDLES/HARDWARE			
Write Style Name:		Write Style Size:	Write Finish Color:
OPTIONAL EXTRAS			
Write any Optional Extras Here:			
ADDITIONAL COMMENTS			
Write any Additional Comments Here:			

Check the pricelist pages to confirm available options. Please check your selection carefully as Timberline cannot be held responsible for incorrect choices. Additional charges may apply.

Installation

INSTALLATION INSTRUCTIONS (CABINETS)

All installation works should be carried out by an experienced and qualified contractor or tradesman.

- All wall hung, floor standing and on legs vanities/linen closets must be mounted to the wall.
- Please check thoroughly prior to installation. See installation instructions.
- During the framing and rough in stages of construction ensure that there are sufficient fixings for the mounting of the vanity cabinet. There should be at least two vertical studs for fixing provided not more than 4" from each edge of the cabinet.
- Ensure that the wall is straight and plumb and free from any bow or twist otherwise the drawers and doors will be out of alignment.
- The solid back of the cabinet must not be damaged, removed, cut or drilled more than is necessary for the access of the plumbing pipes.
- During installation the cabinet should be fixed with screws through the solid back of the cabinet. The screws should be suited to the stud material and have a pan or counter sunk head. Provide a horizontal row of screws within 4" vertically from the top of the cabinet at a maximum of 12" horizontal spacing. The screws closest to the left and right edge of the cabinet should be within 4" of each side.
- Prior to fixing the top to the cabinet with silicone ensure that the cabinet is level and plumb in all directions. If not remove the cabinet and pack or straighten the wall accordingly.
- After installation use the adjusting screws of the hinges and drawer runners to align the doors and drawers.

Detailed instructions are included with the vanity. Timberline Bathroom Products makes every effort to supply our clients with outstanding quality products, we can in no way be held responsible for any damages arising from failure due to the method in which the vanity was installed or commissioned.

Refer to www.timberlinebp.com/resources/downloads/ for more detailed installation guides and warranty information, as well as specific install information on Tuscany vanity and Floating Shelves.

CARE INSTRUCTIONS

For all surfaces use only a soft cloth and a weak solution of a non-abrasive cleaner. Do not use any abrasive, acid or alkaline based cleaners. A moist microfiber cloth will give the best results. Avoid sharp objects and keep heat and hot objects away from tops. Cabinets should be installed at least 12" away from showers or bathtubs to avoid water damage. Care must be taken to immediately dry any condensation, spillage or water leakage that may gain access to the cabinet, as water damage is not covered under warranty.

To keep your bathroom furniture looking sparkling bright ask about our Timberline 3 Dimension Cleaners. They don't only clean, they leave a silky smooth polished finish.

Cleaner and Polish	SKU	MSRP
3 Dimension Cleaner and Polish	CLE-CLE-3D	\$31
Streak Free Glass Wax	WAX-CLE-GLASS	\$31



3 Dimension Cleaner & Polish suitable for nearly all bathroom surfaces



3 Dimension Streak Free Glass Wax and mirror polish for lasting shine

Warranty

Timberline Bathroom Products ensure that our products are manufactured using only high quality materials and workmanship. Should you find fault with either materials or workmanship within the warranty period noted below, Timberline Bathroom Products will, at its discretion, repair or supply a replacement for the faulty product or component.

WARRANTY PERIODS:

Vanities	10 years	Sinks	5 years
Linen Closets	10 years	Cambria Countertops	Full Lifetime
Mirrored Cabinets (excluding mirror)	10 years	Under Cabinet Lighting	1 year
Mirrors	1 year	Dolomite/Mineral Composite Tops	5 years
Commercial Use: ALL PRODUCTS	1 year	SilkSurface Tops	5 years

The Timberline Bathroom Products warranty will only apply where the product has been installed by qualified contractor and in full accordance with our installation instructions. This warranty does not cover damage by improper installation, accident, misuse, abuse, negligence, excessive wear and tear, improper care and lack of maintenance, heat damage, use of harsh abrasive cleaners, water and natural causes such as sunlight, humidity and other environmental conditions.

Adjustment of doors and drawers is undertaken during manufacture and readjustment will be necessary after installation – this does not form part of the warranty. Should a representative from Timberline be required to realign doors/drawers, a minimum call out fee of \$330.00 will be charged.

It should be noted that all cabinets are manufactured from water resistant materials. This does not mean that they are waterproof. Care must be taken to immediately dry any condensation, spillage or water leakage that may gain access to the cabinet as water damage is not a justifiable claim. Installation, cleaning and maintenance instructions must be followed to ensure validity of warranty.

Timberline Bathroom Products' liability is limited to repair, replacing, or giving a credit for the faulty goods and it does not

include installation expenses and/or damages or removal of any unit. The purchaser must provide proof of purchase when making a claim. The warranty will be void if a damaged or incorrect unit has been installed.

Our goods come with guarantees that cannot be excluded under the American Consumer Law. You are entitled to a replacement or refund for a major failure and for compensation for any other reasonably foreseeable loss or damage. You are also entitled to have the goods repaired or replaced if the goods fail to be of acceptable quality and the failure does not amount to a major failure.

To make a claim please contact Timberline by phone on 888 844 0102 or sales.usa@timberlinebp.com

Please note that installation of any product is regarded as acceptance of that product and therefore no claims for faulty or damaged goods can be made after installation. Any claim for faulty or damaged goods must be made within 48 hours from receipt of product.

Register your warranty online at www.timberlinebp.com then click **Make a Warranty Claim**. We'll keep a record of your purchase to save you the hassle. That way you know we will always have your warranty information saved - just in case something goes wrong.

Packaging That Gets to You

There is nothing worse than the excitement of opening your new vanity only to find it has been damaged on the way. Not with our SUPER CRATES!

Every product we ship comes in its own ultra strong SUPER CRATE. And yes - they are strong enough to support a pickup!

Every vanity, linen closet and mirrored cabinet comes in its own SUPER CRATE! That's our way of making sure it gets to you!



THE ULTIMATE STRENGTH TEST

Having a great looking vanity is one thing. Having a vanity strong enough for your whole family is another!

We tested the strength of a 60" wall hung vanity installed using the bare minimum number of fixings to meet our installation instructions. Then we loaded it with 37 bags of cement totaling 1,600lbs. With our solid rear panel which is tongue and grooved into the cabinet the vanity supported this full weight. With Timberline, you can be assured you aren't just getting a pretty face! Our vanities are tough!

1,600 lbs! On a wall hung vanity!



What Makes Our Furniture Special?



Doweled Tongue And Groove Jointing

All our solid backs and bases are assembled with a tongue and groove joint with multiple doweled fix points. This creates exceptional strength and durability, particularly for wall mounted cabinets. The tongue and groove joint prevents the side from pulling away from the back when pressure is placed on the vanity top. The dowels ensure a clean, hardware free look.



Soft-Close Hinges

Only the best Blum European fully adjustable hinges are used. This allows them to be easily adjusted and offer a long life span. All hinges include built in soft-close mechanisms.



Solid Plywood Board

All our cabinet boxes are manufactured with a 18mm / 3/4" plywood core HPL white faced board. This makes for a light, yet highly durable cabinet, that wont swell or bubble with water damage.



Bracket Free Solid Vanity Back

At Timberline we always use a full 3/4" / 18mm solid back. This ensures the greatest stability for our vanities and makes mounting and installing a breeze. We never use a 1/8" paper lined MDF back.



Timberline

www.timberlinebp.com

For your nearest distributor go to timberlinebp.com/find-a-store/

SEPTEMBER 2024 - FEBRUARY 2025

300 Industrial Drive, Redwood Falls, MN 56283

T: 1.888.844.0102

E: sales.usa@timberlinebp.com